

TRADE

2022

CATALOGUE

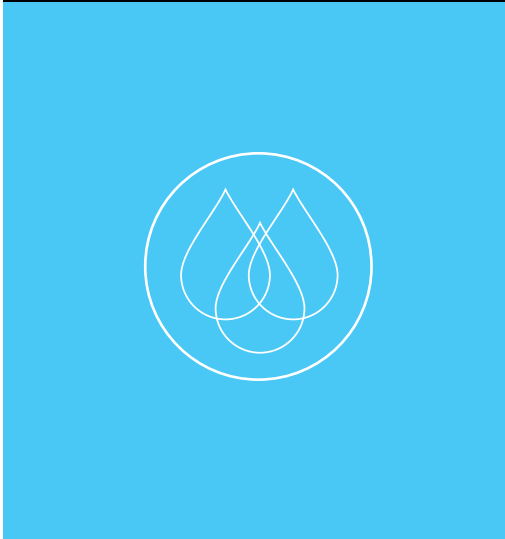

INSTALLATION
COMPONENTS FOR
THE WATER
TREATMENT INDUSTRY



AQUAMATIC

MAKING IT SIMPLE

How to Order

By Phone:

+44 (0)1483 861599

Telephone orders are received personally from 8:30am - 4:30pm Monday to Thursday and 8:30am - 4:00pm on Fridays
We are always closed on bank holidays.

By Email:

sales@aquamatic.co.uk

For quick and efficient ordering, please note we will always respond to confirm receipt of your order.

By App:

See next page for more details of the new, efficient way to order.

Next day delivery

All orders received by 2pm are despatched the same day. Parcels are sent by Next Day Service. Overseas orders are charged at cost. Smaller packages can be posted, postage and packaging will be charged at cost. Timed deliveries are also available, please call for options and prices.

Collecting your order

You are welcome to come and collect goods. Please telephone or email your order through first and we will have your goods packed and ready for you.

Catalogue

Unpriced copies of the catalogue can be downloaded from the app or our website:
www.aquamatic.co.uk

Also available on request we can supply unpriced versions for you to use with your customers.

Stock

Most items from the catalogue are available from stock. Items with part numbers in **red** may have to be ordered.

Satisfaction Guarantee

If you are not completely satisfied with anything you buy from us, simply return it, and we will exchange it or refund your money.

Prices

Prices are in GBP, are trade nett and exclude VAT & carriage which is chargeable at the current rate. We try to maintain the printed prices for the life of the catalogue, but due to the continued unsettled financial climate, prices may change at any time without notice.

Payment

Payment terms are cash with order unless otherwise agreed in writing. We also accept major credit cards.



WE'VE JUST MADE IT EVEN EASIER FOR YOU

THE NEW APL APP

We know how important your time is. So we have moved with the times and taken our catalogue online, allowing you to order quickly, whenever or wherever you like. The right taps, filters and installation products are now at your fingertips through this app, purpose made with you in mind.

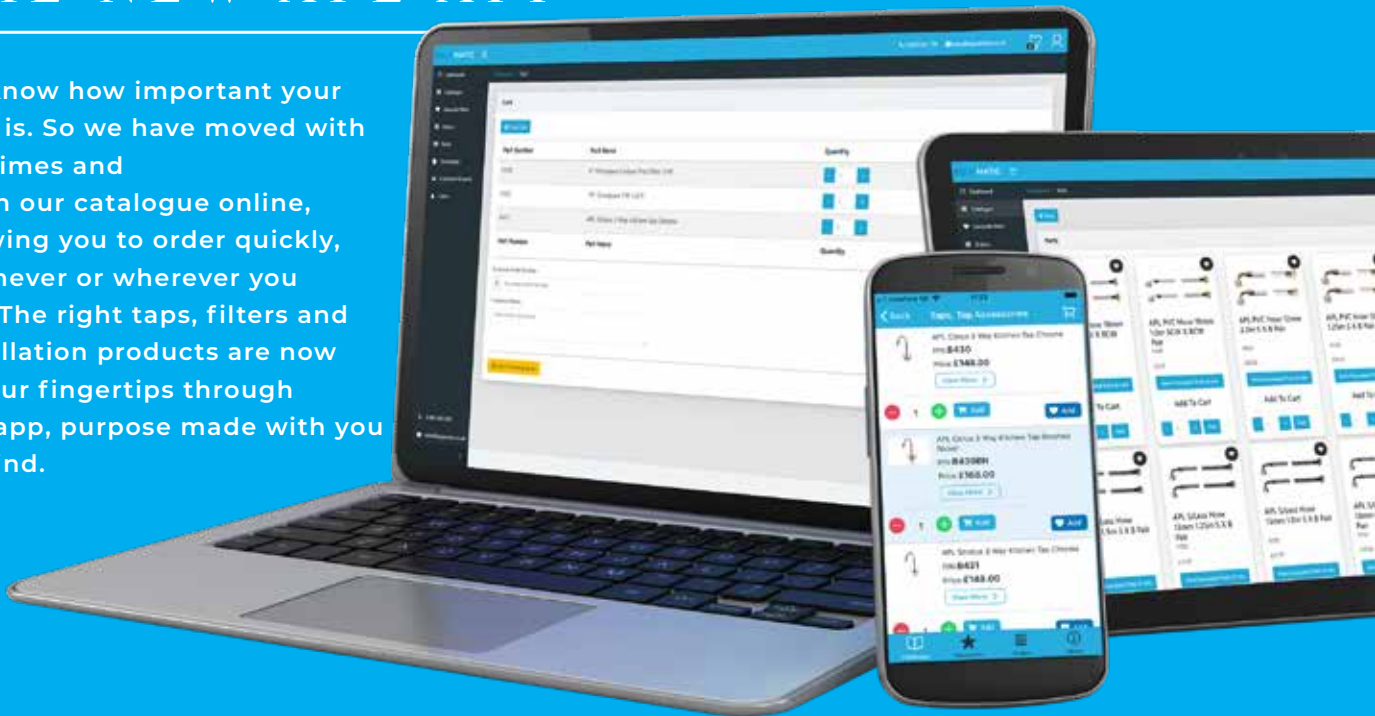

Our same friendly, professional service, just got better.

Contact us now to open up a new, easy and convenient way of ordering the products you need to keep your business running.

Benefits include:

- Order anytime, anywhere
- Works and syncs on all devices: PC, Mobile, Tablets
- Features a handy 'downloads' section
- News updates
- Order history so you can easily see 'what I had before'
- Easy checkout process
- All your favourites in one place for faster ordering

Contact us today on sales@aquamatic.co.uk and we will set you up. We are more than happy to spend time talking you through it and customising it for your use. And of course, if you still want to chat with us, we are more than happy to hear from you on the same number as always.

CUSTOM MADE

APL Cirrus

Contemporary high quality styling with brushed nickel or chrome finish. Perfect in new or old style kitchens.

DESCRIPTION & COST:

B430	APL Cirrus (chrome)	172.00
B430BN	APL Cirrus (brushed nickel)	194.00

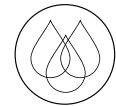

THREE WAY TAP



BRUSHED NICKEL

B430BN



B430

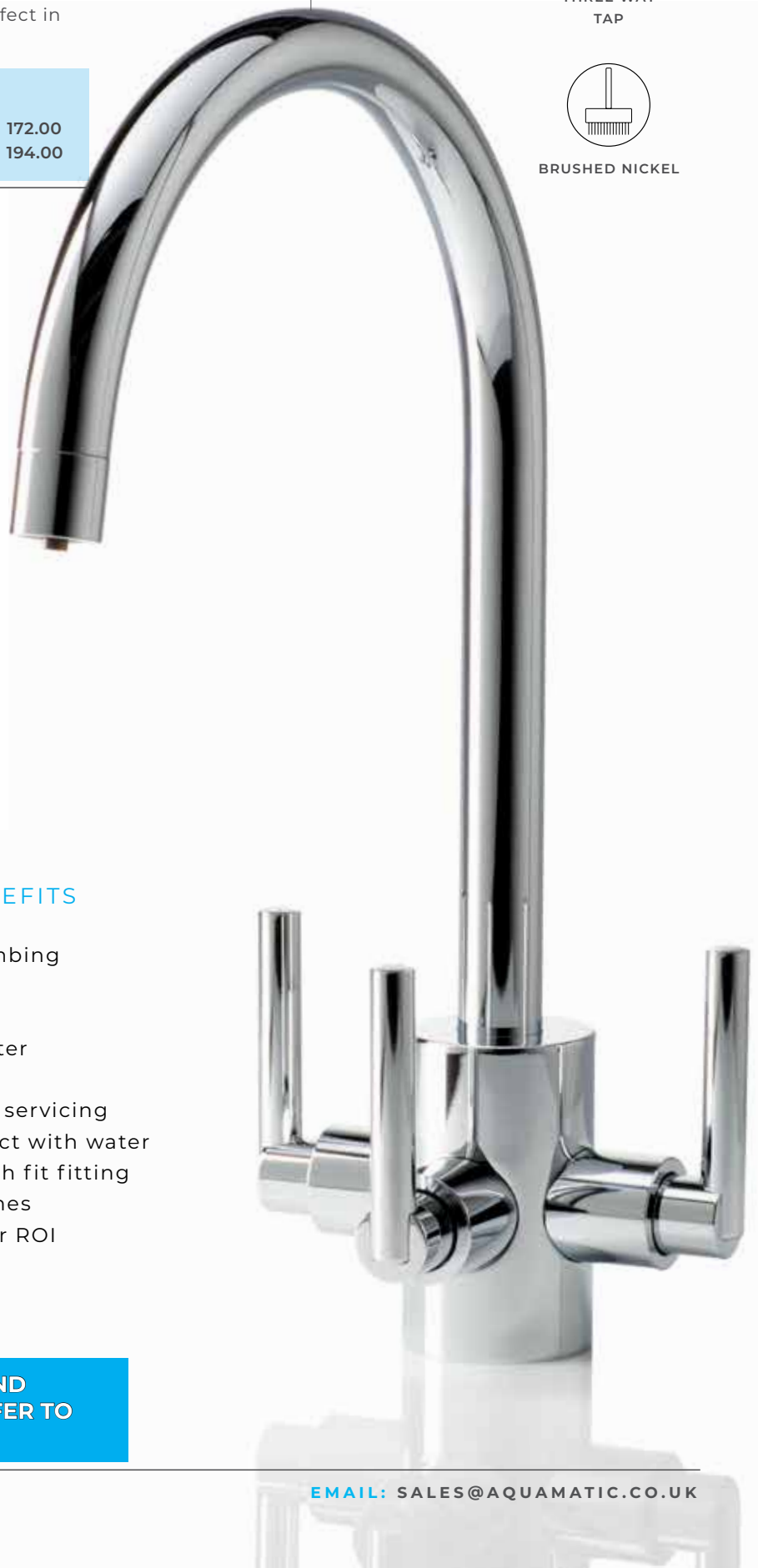

THE NEW APL 3 WAY TAPS
 HERE ARE SOME OF THE BENEFITS

- 2 Stunning Styles
- Suitable for all UK types of plumbing
- Popular 3 lever design
- High Flow capability
- Dedicated path for drinking water
- Easy installation
- Supplied tools for installation & servicing
- Lead free brass - when in contact with water
- Plain tailed connections for push fit fitting
- Chrome or brushed nickel finishes
- Value for money, creating better ROI
- Bespoke protective packaging
- Great after sales customer care
- 5-year warranty (T&Cs apply)

FOR TAP DIMENSIONS AND SPECIFICATIONS PLEASE REFER TO OUR TAP CATALOGUE

CUSTOM MADE

APL Stratus

A modern version of a stylish past era, but with a three way tap. Highly finished in either chrome or brushed nickel. Perfect for Shaker or Cottage style kitchens.

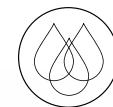

THREE WAY TAP



BRUSHED NICKEL

DESCRIPTION & COST:

B431	APL Stratus (chrome)	172.00
B431BN	APL Stratus (brushed nickel)	194.00

B431BN



B431



MADE FOR THE UK, SO SUITABLE FOR ALL PLUMBING TYPES. 15MM TAILS FOR THE BEST FLOW RATES
 SEE PAGE 7 FOR OUR NEW RANGE OF TAP TAILS AND ISOLATING VALVES TO MAKE THESE EVEN QUICKER AND EASIER TO INSTALL

K229



FOR WARRANTY TERMS AND CONDITIONS, SEE PAGE 48

QUALITY ASSURED

Franke Filterflow Taps

Franke Filterflow taps are tried and trusted with a well recognized name. All come with all the necessary fittings/valves/ connections required for installation. As these taps are made for the UK market, they are suitable for both vented and unvented systems. These are obviously slightly pricier than the imported taps, but the quality and the fact that they are guaranteed and supported nationwide means that you can install these with confidence.

Franke now only supply these taps with their own filter kit. The part number and prices reflect this change. Part numbers in **RED** might have to be ordered in.

Please note that in order to make the price attractive, we make less margin on these, so we regret that we are unable to offer the free carriage on Franke products, unless delivered with other goods which exceed £250.

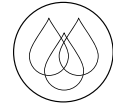

THREE WAY
TAP



B226



B228



Filter Kit now supplied with all Franke taps



DESCRIPTION & COST:

B226	Franke Olympus Chrome Tap and Filter	522.99
B227	Franke Olympus Silksteel Tap and Filter	570.18
B228	Franke Doric Chrome Tap and Filter	522.99
B229	Franke Doric Silksteel Tap and Filter	570.18

DON'T FORGET
 WE CAN SUPPLY ANY FRANKE OR
 ABODE PRODUCT

QUALITY ASSURED

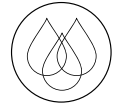

THREE WAY
TAP

Gosford & Atlas 3 Way Taps

These 3 way taps offer a quality product without a filter so that you can use your own (or preferably one of ours) at a reasonable price. All are made for the UK market so are suitable for both vented and unvented water systems and are supplied with all the fittings suitable for connection to 15mm. Filter connection is 1/4" but supplied with fittings for both 1/4" and 3/8" tube.



DESCRIPTION & COST:		
B335	Gosford 3 Way Tap Chrome	187.70
B336	Gosford 3 Way Tap Brushed Nickel	224.67
B337	Atlas 3 Way Tap Chrome	199.57
B338	Atlas 3 Way Tap Brushed Nickel	220.65

TECHNOLOGY IS GREAT!!

But please remember we are still here in the office and would love to talk to you or see you, and if you need any help with anything we are here for you, as always.

(with no annoying automated phone systems or hold music!)

MULTI OPTIONS

Iso Valves

We always recommend that you fit isolating valves to any new tap. This makes life so much easier for you or anyone else should you ever need to service or remove the tap. Below are 2 types of iso valve that are suitable for this. B29 is a full bore valve. We also have fast fit hoses kits. These flexible connections are so much quicker and easier to fit. K227/8 are 300mm long, K229 are 400mm long. K227 has 15mm pushfit fittings each end. K228 is 15mm pushfit x 15mm stand pipe (fits in 15mm compression or pushfit fitting). K229 are mono x 15mm standpipe. K227, K228 and K229 are suitable for use with the new APL taps and Abode taps. K227 & K228 are not suitable for use with Franke.



DESCRIPTION & COST:

B29	15mm Full Bore Iso Valve	4.80	P934	15mm JG Iso Valve	6.39
K227	APL Tap Fast Fit Kit 15mm P/F x P/F	14.83	K228	APL Tap Fast Fit Kit 15mm P/F x S/P	13.77
K229	APL Tap Fast Fit Kit Mono x S/P	7.91			

TAP ADAPTORS & FAUCET TOOLS

Adaptors for Threaded Faucets

All faucets with threaded stems have a 7/16" tail. You therefore need one of these adaptors. P113 for 1/4" tube. P114 for 3/8" tube.



DESCRIPTION & COST:

P113	1/4" x 7/16" Tap Adaptor	1.22
P114	3/8" x 7/16" Tap Adaptor	1.24

Adaptors for Push Fit Faucets

These are the adaptors for any of our pushfit faucets.



DESCRIPTION & COST:

P110	3/8" Straight Coupling	1.19
P112	3/8" x 1/4" Reducer	1.18

Adaptors for 1/2" Tails

Standard taps have 1/2" tails.



DESCRIPTION & COST:

P115	1/4" x 1/2" Tap Adaptor	1.24
P116	3/8" x 1/2" Tap Adaptor	1.24

Faucet installation tool

B514 is purpose made for installing faucets. Quick to use, even in the tightest spots.

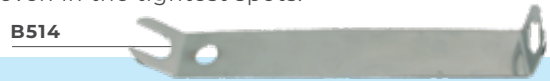

DESCRIPTION & COST:

B514	Faucet Installation Wrench	5.30
------	----------------------------	------

Faucet Box Spanner

B515 is a useful box spanner for installing faucets. Comes with a bar, but is sometimes easier to use an adjustable wrench to turn it.



DESCRIPTION & COST:

B515	Faucet Installation Box Spanner	2.30
------	---------------------------------	------

Monobloc Spanners

A useful set of box spanners for installing most types of monobloc mixer taps. 3 pieces (6 sizes) + bar.



DESCRIPTION & COST:

T716	Monobloc Spanner Set	5.72
------	----------------------	------

MODERN STYLING

APL Intertap

A lot of thought and effort has been put into this product and it is now the new everyday tap for most installations and is far more popular than the old touch type taps which have been around forever and are now somewhat dated. With it's modern good looks and a whole host of useful features as well as a very realistic price, we are sure you will be impressed. Please take a moment to check out the features below.

MODERN STYLING

To suit the majority of modern sinks/kitchens

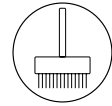

ALSO AVAILABLE IN
 BRUSHED NICKEL

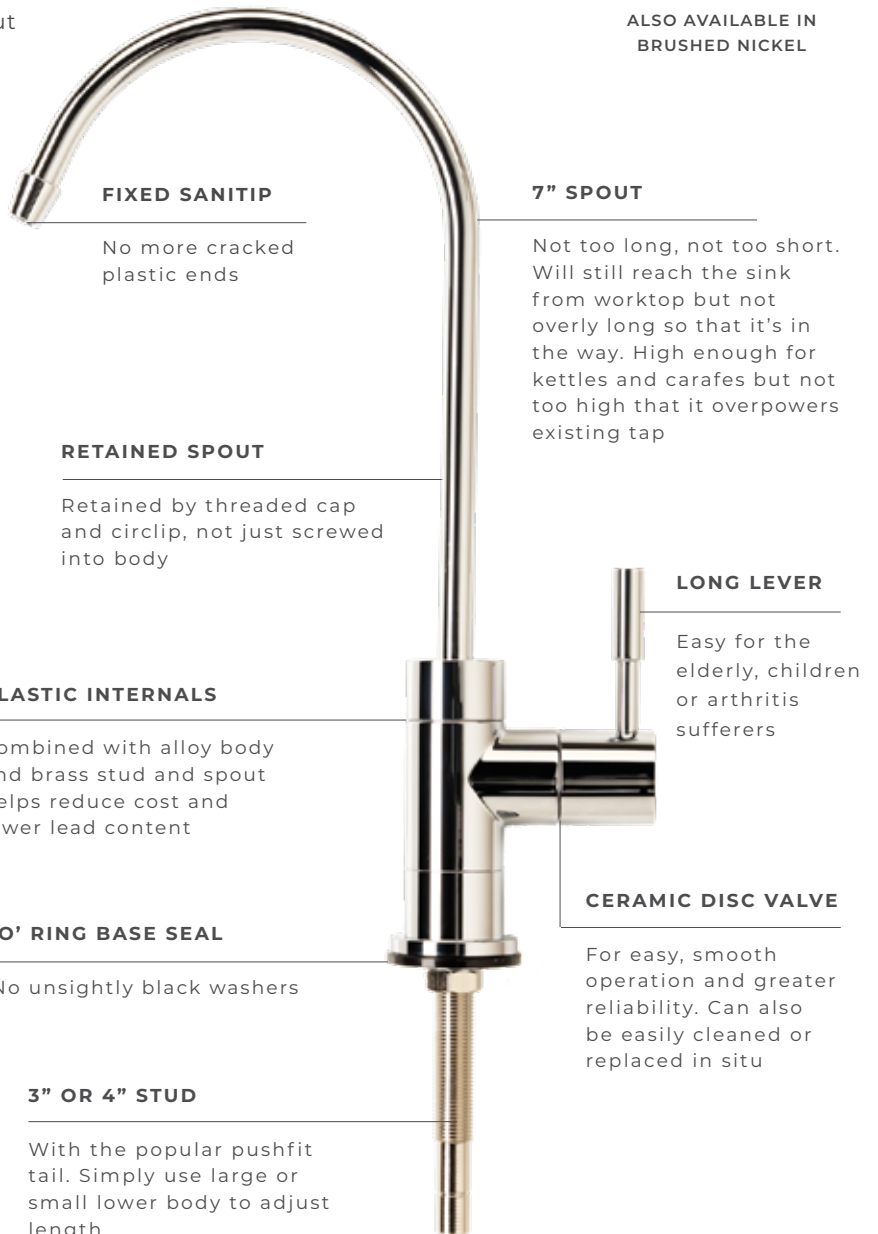

FIXED SANITIP

No more cracked plastic ends

7" SPOUT

Not too long, not too short. Will still reach the sink from worktop but not overly long so that it's in the way. High enough for kettles and carafes but not too high that it overpowers existing tap

RETAINED SPOUT

Retained by threaded cap and circlip, not just screwed into body

LONG LEVER

Easy for the elderly, children or arthritis sufferers

PLASTIC INTERNALS

Combined with alloy body and brass stud and spout helps reduce cost and lower lead content

CERAMIC DISC VALVE

For easy, smooth operation and greater reliability. Can also be easily cleaned or replaced in situ

'O' RING BASE SEAL

No unsightly black washers

3" OR 4" STUD

With the popular pushfit tail. Simply use large or small lower body to adjust length



OPTIONAL LOWER BODY

Has a smaller diameter for tight corners and also allows longer stud for thick worktops



INTERMEDIATE SIZE

Fits right in the middle of the current range

DESCRIPTION & COST:

B20 APL Intertap Chrome	22.80
B20BN APL Intertap Brushed Nickel	25.82

SIMPLE TO USE

6 in 1 Quarter Turn Push Fit Multi Tap

This unique tap brings 6 options in one box. 3 different handles and 2 different spouts means that just one product will provide a choice of 6 styles from 1 box. So easy, so useful, so cost efficient. This tap comes with quarter turn ceramic disc operation as well as the popular pushfit stem.



DESCRIPTION & COST:

B15QTMULTI Quarter Turn Push Fit Multi tap

25.60



TRY OUR APP

A safe, secure and fast way of ordering
the products you need to keep your
business running.



Just click on the heart in the app to start creating your own
favourites list, and we can even prioritise your
list so your most common parts appear first



MADE FOR YOU



Full Flow Ball Valves

These valves are extremely popular as they have been designed to our exact specification for use when installing softeners. Here are some of the useful features that we have designed into them.

- **Smallest possible profile for a full bore valve**
- **Metal levers long enough to provide easy operation**
- **Silky smooth easy action**
- **Fully compatible with our tees and hoses**
- **Universal colouring and labelling across the entire range for easy customer identification**
- **All WRAS approved**

Listed here are the individual valves, bypass packs and sets are over the page.

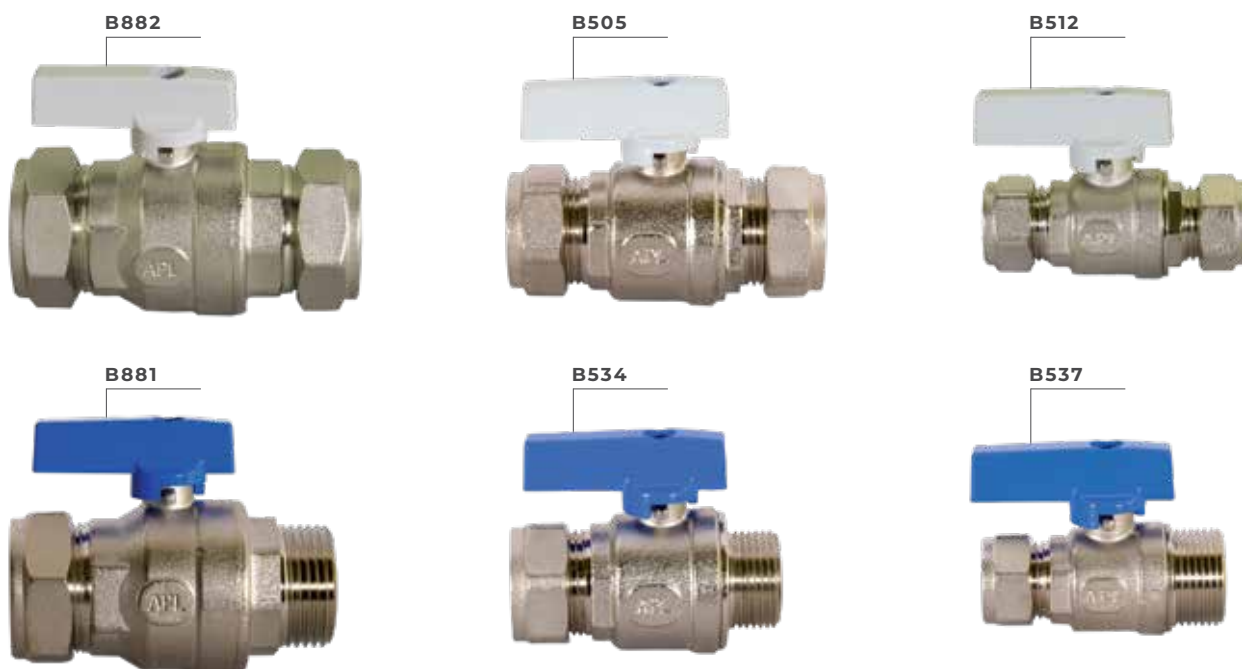

DESCRIPTION & COST:

B505	22mm Full Flow Valve	11.33	B512	15mm Full Flow Valve	7.18
B534	22mm x 3/4" Full Flow Valve	10.13	B537	15mm x 3/4" Full Flow Valve	6.27
B881	28mm x 1" Full Flow Valve	14.55	B882	28mm x 28mm Full Flow Valve	15.85



WRAS Approval

Unless stated otherwise, all items in a box with the WRAS logo shown here, have been tested and approved by WRAS

EASY INSTALLATION

Bypass Tees

Here is a product that will transform your installations.

These Tees have a check valve built into one of them to save cost and space. They can be used in a variety of configurations - see examples - all of which are quick to assemble in the minimum amount of space and time. They are shown here in just a few of the many configurations. The bottom picture shows how you can use a further Tee to provide an outlet for a hard water supply for example.



Here are just a few of the benefits:

Price advantage - less than a check valve and 2 Tees.

Time saving - less components to assemble.

Space saving - considerably smaller than conventional arrangement.

All nickel plated for a smarter installation.

Conveniently grouped close together for easier customer identification and operation.



The above pictures of a typical bypass arrangement show the progress we have made in constantly finding and developing products to make your installations easier, quicker, and more cost effective. They are available as a pair of Tees with integral check valve, single Tee only, or as a pack with the bypass valves.

**Available in:
 15mm Bypass Tees**

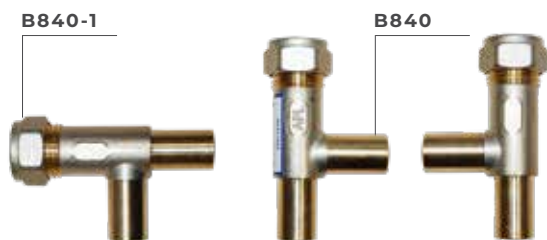

22mm Bypass Tees

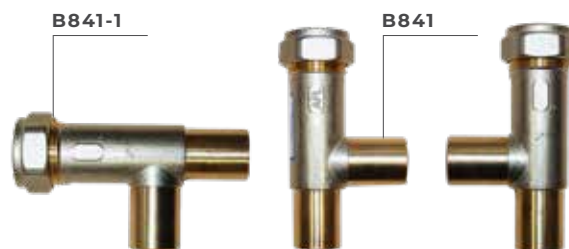

DESCRIPTION & COST:

B840	Pair 15mm Bypass Tees W/Check	9.64
B840-1	15mm Bypass Tee Only	3.93

B841	Pair 22mm Bypass Tees W/Check	15.96
B841-1	22mm Bypass Tee Only	7.42

15mm Bypass Set



The valves in this by-pass set are of the very best quality. We have found over the years that since the by-pass set is one of the most important parts of the installation it is worth spending a few pence more. These valves have a large bore size for high flow rate and will not scale up or let by in the years to come. Connections are 15mm compression x 3/4" B.S.P. for connection to our hose fittings with the by-pass valve being 15mm C X C. Supplied with labelled levers and customer instruction label. Also available as a pack with tees - B842.

15mm Bypass Set

B30 15mm copper x hose by-pass set.

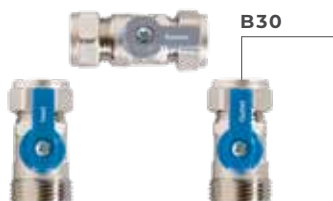

15mm Bypass Pack

Same as B30 plus a pair of tees with check valve.



DESCRIPTION & COST:

B30	15mm Bypass Set	17.39
-----	-----------------	-------

B842	15mm Bypass Pack	27.04
------	------------------	-------

BESPOKE PRODUCT



Full Flow Bypass Sets and Packs

A full range of 15, 22 and 28mm bypass sets and packs using the new full flow valves and tees shown on the previous pages. They all feature the same colour coding and labelling so that you have a complete matching 'family' of valves.

All are individually labelled and have a customer instruction label as well.

15mm Full Flow

B538 15mm copper x hose bypass set.



DESCRIPTION & COST:

B538 15mm C x H Full Flow Bypass Set 19.72

15mm Full Flow Bypass Pack

Same as B538 plus a pair of tees with check valve.

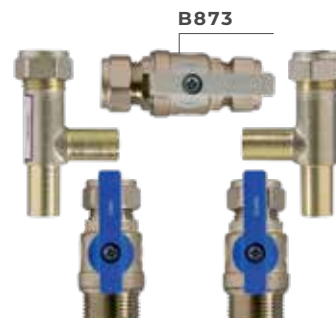

DESCRIPTION & COST:

B873 15mm Full Flow Bypass Pack 29.00

22mm Full Flow

B535 22mm copper x hose bypass set.



DESCRIPTION & COST:

B535 22mm C x H Full Flow Bypass Set 31.59

22mm Full Flow Bypass Pack

Same as B535 plus a pair of tees with check valve.



DESCRIPTION & COST:

B843 22mm Bypass Pack 47.55

28mm Full Flow

B883 28mm copper x hose by-pass set.



DESCRIPTION & COST:

B883 28mm C x H Full Flow Bypass Set 44.93

See Page 30 for our new Bypass instruction Labels



WHEN YOU NEED CUSTOM MADE

Hose Assemblies

We have our own hose assembly equipment which means that we can make custom made hoses quickly if required in either plastic or stainless braided. It also means we have a more reliable stock situation. By sourcing quality materials and investing in high pressure test equipment, we can be sure of the integrity of our products. If you have a requirement for any hose assembly that is not listed on the next page, please call with your specifications for a quote.



WRAS Approval
All of our hose assemblies have WRAS approval

Hose Packaging

Unless requested otherwise, we are now supplying our pairs of hoses packed in a long bag with a header card with Euro slot. This will make it a lot easier for you to store these items as you will be able to hang them on hooks and to identify what's in each pack. The header card will also have the length and part number on as well.



Pre-assembled Hoses



The standard hoses here are available in either 10mm or 12mm with one straight connector and one bent connector. 10mm has plastic fittings with captive washers whilst 12mm has brass fittings with plastic nuts. Supplied as a pair. Various lengths available. Not recommended for use with hot water, use the stainless hoses for this. **We can supply any pre-assembled hoses to order. Just ring with your requirements and we will be happy to quote.**

10mm Straight x Bent



12mm Straight x Bent



DESCRIPTION & COST:

H146	Pair 10mm Hoses 1.25m	12.83	H834	Pair 12mm Hoses 2.0m	27.18
H147	Pair 10mm Hoses 1.0m	10.70	H148	Pair 12mm Hoses 1.25m	20.29
			H835	Pair 12mm Hoses 1.0m	17.84
			H781	Pair 12mm Hoses 0.75m	15.37

SEE PAGE 43 FOR OUR GUIDE TO HOSES AND ASSOCIATED FITTINGS

ALL LENGTHS



13mm Stainless Hoses

All with 3/4" nickel plated brass end fittings and nuts. 13mm bore for standard installations. Various lengths and formats available. Suitable for use on hot water. **We can supply any pre-assembled hoses to order. Just ring with your requirements and we will be happy to quote.**

13mm Straight x Bent



DESCRIPTION & COST:

H786	Pair 13mm S/less Hoses St x B 1.5m	26.10
H782	Pair 13mm S/less Hoses St x B 1.25m	23.51
H783	Pair 13mm S/less Hoses St x B 1.0m	20.91
H784	Pair 13mm S/less Hoses St x B 0.75m	17.22
H785	Pair 13mm S/less Hoses St x B 0.5m	15.71

13mm Bent x Bent



DESCRIPTION & COST:

H980	Pair 13mm S/less Hoses B x B 1.5m	30.56
H979	Pair 13mm S/less Hoses B x B 1.25m	27.97
H978	Pair 13mm S/less Hoses B x B 1.0m	25.38
H977	Pair 13mm S/less Hoses B x B 0.75m	23.22
H976	Pair 13mm S/less Hoses B x B 0.5m	20.19



19mm Stainless Hoses

All with 3/4" nickel plated brass end fittings and nuts. 19mm bore for hi-flo installations. Various lengths and formats available. Suitable for use on hot water. **We can supply any pre-assembled hoses to order. Just ring with your requirements and we will be happy to quote.**

19mm Straight x Bent



DESCRIPTION & COST:

H775	Pair 19mm S/less Hoses St x B 1.5m	45.94
H769	Pair 19mm S/less Hoses St X B 1.25m	41.26
H772	Pair 19mm S/less Hoses St X B 1.0m	36.69
H773	Pair 19mm S/less Hoses St X B 0.75m	32.01
H774	Pair 19mm S/less Hoses St X B 0.5m	27.45

19mm Bent x Bent



DESCRIPTION & COST:

H981	Pair 19mm S/less Hoses B x B 1.5m	53.87
H829	Pair 19mm S/less Hoses B x B 1.25m	48.23
H830	Pair 19mm S/less Hoses B x B 1.0m	43.60
H831	Pair 19mm S/less Hoses B x B 0.75m	38.28
H832	Pair 19mm S/less Hoses B x B 0.5m	34.35

Straight x Straight and other lengths are also available.

All our WRAS Approved hoses are made on site and in most cases if ordered by 2pm can usually be despatched same day. Please contact us for further information.

25mm Stainless Hoses

1" hoses for larger softeners. These are 25mm bore with 1" connections and supplied with fibre washers. **We can supply any pre-assembled hoses to order. Just ring with your requirements and we will be happy to quote.**

25mm Straight x Bent



DESCRIPTION & COST:

H984	Pair 25mm S/less Hoses St x B 1.5m	67.01
H767	Pair 25mm S/less Hoses St x B 1.25m	61.21
H833	Pair 25mm S/less Hoses St x B 1.0m	55.70
H768	Pair 25mm S/less Hoses St x B 0.75m	50.08

25mm Bent x Bent



DESCRIPTION & COST:

H989	Pair 25mm S/less Hoses B x B 1.5m	87.49
H988	Pair 25mm S/less Hoses B x B 1.25m	81.78
H987	Pair 25mm S/less Hoses B x B 1.0m	76.25
H986	Pair 25mm S/less Hoses B x B 0.75m	70.55

INSTALLATION MADE EASY

**TAILOR
MADE KITS**
WE ARE HAPPY TO
SUPPLY ANY KITS
MADE TO YOUR
REQUIREMENTS.
JUST ASK...

Standard 15mm Fitting Kits

In houses with vented systems this 15mm fitting kit is suitable for the installation of most water softeners. Contains all the components necessary for the D.I.Y. or trade installer. With pre-made hoses for easier installation. Contains the following items:-

- 1 x Pair of 12mm Hoses (see below for length options)
- 1 x B30 Chrome By-Pass set
- 1 x B840 Pair ByPass Tees W/Check
- 1 x S182 Clip for Drain
- 3m x Drain Hose
- 4 x P155 Washer

All components except drain hose have WRAS approval.



DESCRIPTION & COST:

K221	15mm Fitting Kit 1.25m	55.46
K267	15mm Fitting Kit 1.0m	50.03
K271	15mm Fitting Kit 0.75m	47.56

15mm Fitting Kit with Plumbing out kit

This kit comprises:- All of the above plus a plumbing out kit (plumbing out kit is not WRAS approved).

DESCRIPTION & COST:

K269	15mm Fitting Kit w/p-out 0.75m	55.60
------	--------------------------------	-------

Hi-flo 15mm Fitting Kits

15mm fitting kit suitable for properties with a combi boiler. Contains all the components necessary for the D.I.Y. or trade installer. With pre-made hoses for easier installation. Contains the following items:-

- 1 x Pair of 12mm Hoses (see below for length options)
- 1 x B538 Full Flow ByPass set
- 1 x B840 Pair By-Pass Tees W/Check
- 1 x S182 Clip for Drain
- 3m x Drain Hose
- 4 x P155 Washer

All components except drain hose have WRAS approval.



DESCRIPTION & COST:

K291	15mm Hi-flo Fitting Kit 0.75m	49.89
K292	15mm Hi-flo Fitting Kit 1.0m	52.36

15mm Hi-flo Fitting Kit with Plumbing out kit

This kit comprises:- All of the above plus a plumbing out kit (plumbing out kit is not WRAS approved).

DESCRIPTION & COST:

K299	15mm Hi-flo Fitting Kit w/p-out 0.75m	58.29
------	---------------------------------------	-------



All of the components in our fitting kits have WRAS approval except for drain fittings and drain hose

Softener Removal Kit

Everything you need to cap off after the removal of a softener, in a handy bag to give to a customer or have on the van.

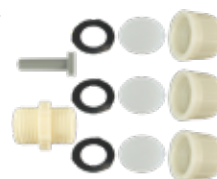

DESCRIPTION & COST:

K207	Softener Removal Kit	2.58
------	----------------------	------

INSTALLATION MADE EASY

22mm Fitting Kits

This kit has been assembled for the installation of water softeners on direct mains systems which are becoming more popular. It contains the following components:-

- 1 x Pair 19mm Stainless Hoses (3 length options)
- 1 x B535 22mm Full Flow Bypass set
- 1 x B841 Pair 22mm ByPass Tees
- 3M x Drain Hose
- 4 x P155 Washer
- 2 x B876 Fibre Washer
- 1 x S182 Clip for Drain

All components except drain hose have WRAS approval.

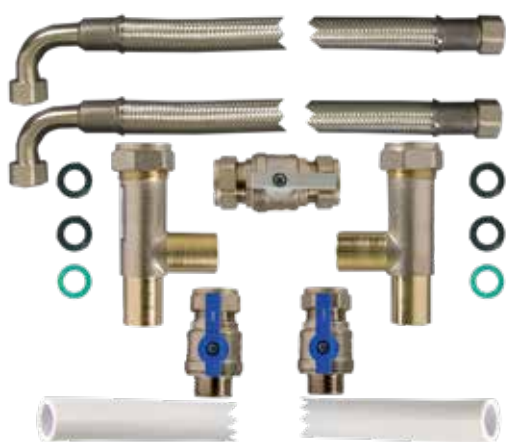

DESCRIPTION & COST:

K233	22mm Fitting Kit 1.25m	93.97
K262	22mm Fitting Kit 1.0m	89.40
K270	22mm Fitting Kit 0.75m	84.72

22mm Fitting Kit with Plumbing out kit

This kit comprises:- All of the above plus a plumbing out kit (plumbing out kit is not WRAS approved).

DESCRIPTION & COST:

K259	22mm Fitting Kit w/p-out 0.75m	92.76
------	--------------------------------	-------



28mm Fitting Kits

All full flow components for the highest flow rate on plumbing systems with 28mm pipework and softeners with 1" connections. Kit contains the following components:-

- 1 x Pair 25mm Stainless Hoses with 4 x Fibre Washers
- 1 x B883 28mm Full flow Bypass Set
- 3m x Drain Hose
- 1 x B877 28mm Check Valve
- 2 x B818 28mm Compression Tees
- 1 x S182 Clip for Drain

All components except drain hose have WRAS approval.



DESCRIPTION & COST:

K258	28mm Fitting Kit 1.0m	130.80
------	-----------------------	--------

28mm Fitting Kit with Plumbing out kit

This kit comprises:- A pair of 25mm SS hoses 1.25m, 28mm bypass set, 2 compression tees, 28mm check valve, 6m of drain/overflow hose, 4 fibre washers, a plumbing out kit, a pipe cover for the overflow 2 clips and 10 clips for the drain hose. (plumbing out kit is not WRAS approved)

DESCRIPTION & COST:

K203	28mm Fitting Kit w/Plumbing out Kit	149.72
------	-------------------------------------	--------

Fitting Kit Packaging

We are now packing all fitting kits in labelled boxes. This gives a much more professional appearance to your customers and is easier to stack and indentify in your stores. If you would prefer your kits in plastic bags instead please advise us when ordering.

EVERYTHING YOU NEED



Inlet Hose

This special food grade re-inforced hose has now been in use for many years and is the hose of choice for water softeners, supplied in white for neat and presentable installations, it has a black Hytrel liner to prevent the formation of bacteria. Available in 10mm, 12mm, and 19mm (30M rolls). We do not recommend this for hot water.



DESCRIPTION & COST:

H141	10mm Inlet Hose 30m Roll	72.32	H149	19mm Inlet Hose 30m Roll	138.56
H142	12mm Inlet Hose 30m Roll	101.10			

Drain Hose

H140. This is an unreinforced P.V.C. hose supplied in white to match inlet hoses and is suitable for drain and overflow applications on most water softeners. Use standard 12mm hose fittings and clips.



Heavy Duty Drain Hose

H145. This is a heavy duty version of the drain hose which has a thicker wall and is therefore much more resistant to kinking. You will need to use the larger clips, S183 or S184L.

DESCRIPTION & COST:

H140	Drain Hose 30m Roll	29.81	H145	Heavy Duty Drain Hose 30m Roll	35.46
------	---------------------	-------	------	--------------------------------	-------



John Guest Tube

John Guest drinking water tube in both 3/8" and 1/4". Both are available in white or blue on 500' (150 metre) rolls. This is the perfect tube for R.O.s and drinking water systems.



DESCRIPTION & COST:

H850	1/4" JG Tubing White 500' Roll	28.85
H851	1/4" JG Tubing Blue 500' Roll	28.85
H852	3/8" JG Tubing White 500' Roll	64.67
H853	3/8" JG Tubing Blue 500' Roll	64.67

Drinking Water Tube

This type of tube as well as being much more flexible and resistant to cracking has a black Hytrel liner (the same as that used in the inlet hoses) to prevent the formation of bacteria. Available in 3/8" and 1/4". Supplied in white on 30m rolls.



DESCRIPTION & COST:

H143	3/8" Drinking Water Tube 30m Roll	41.95
H144	1/4" Drinking Water Tube 30m Roll	30.48

Tube Inserts

3/8" and 1/4" tube inserts now only available in plastic.



DESCRIPTION & COST:

F288	Plastic Tube Insert for 3/8" Tube	0.12
P642	Plastic Tube Insert for 1/4" Tube	0.09

Just type in 'hose' into the search facility on the app to bring up everything you need for assembling hoses

INSTALLATION MADE EASY

'O' Clips

A quick professional clip for securing hoses to fittings. Use 5/8" for 10mm inlet and drain hose connections and 3/4" for 12.5mm inlet hose connections. 25-28mm is for hi-flow inlet hose.

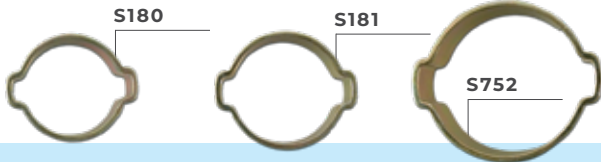

DESCRIPTION & COST:

S180	5/8" 'O' Clip	0.15
S181	3/4" 'O' Clip	0.17
S752	25-28 'O' Clip	0.30

'1 Ear' Clips

We have selected these clips for use with our high pressure inlet hoses. The unique design ensures a full 360 degree contact with the fitting. Use the special tool shown (T702) for fast easy operation, simply squeeze the fitting fully closed and it will then release to leave approx 1mm gap for normal expansion and movement.



DESCRIPTION & COST:

S753	'1 Ear' Clip for 10mm Hose	0.30
S754	'1 Ear' Clip for 12mm Hose	0.30

Normal Closing Pincer

T702. Use this tool for closing both 'O' clips and '1 ear' clips above. Can also be used to remove clips if required.



DESCRIPTION & COST:

T702	Normal Closing Pincer	17.66
------	-----------------------	-------

Herbie Clips

These clips are ideal for drain hoses. They are quick and simple to use, can be reused and will not corrode, thoroughly recommended.



DESCRIPTION & COST:

S184	Herbie Clip for Drain Hose	0.44
S184L	Large Herbie Clip for H/D Drain Hose	0.44

Pin Plugs

Pin plugs for nail clips.

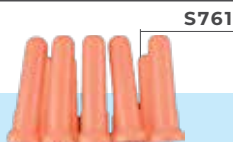

DESCRIPTION & COST:

S761	Nail Plug (box 200)	9.98
------	---------------------	------

Worm Drive Clips

Standard worm drive hose clips. 8-16mm is suitable for drain hose connections and 16-22mm is suitable for inlet hose connections.

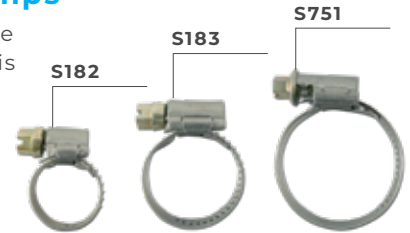

DESCRIPTION & COST:

S182	8-16mm Worm Drive Clip	0.22
S183	16-22mm Worm Drive Clip	0.24
S751	28-32mm Worm Drive Clip	0.33

Stainless Worm Drive Clips

Same as above but all stainless steel. 8-16mm (S192) and 16-22mm (S193).



DESCRIPTION & COST:

S192	8-16mm Stainless Worm Drive Clip	0.43
S193	16-22mm Stainless Worm Drive Clip	0.46

Flexible Driver

Flexible driver specifically for worm drive hose clips. The socket end with flexible shaft means you will be able to apply ample pressure at any angle without the usual slipping.



DESCRIPTION & COST:

T711	Flexible Driver For Worm Drive Clips	5.58
------	--------------------------------------	------

Nail Clips

These clips are excellent quality with hardened nails. Available in 9mm and 16mm for 3/8" drinking tube and drain hose respectively. 22mm version also available.

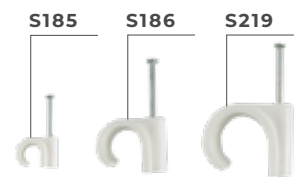

DESCRIPTION & COST:

S185	9mm Nail Clips (box 100)	2.87
S186	16mm Nail Clips (box 100)	8.00
S219	22mm Nail Clips (box 100)	11.24

Pipe Covers

Particularly useful for tidying the overflow pipe. Fits 15mm pipes. Not suitable for HD drain hose.



DESCRIPTION & COST:

S760	Pipe Cover (bag of 50)	21.14
------	------------------------	-------

GET IT TOGETHER

10mm Hose Components

10mm Inlet Hose Connectors

Simply assemble using washing up liquid or silicone spray and secure with any of the clips shown. Available with or without nut and washer. Spare nuts and washers are also available as are screened filter washers (P157).

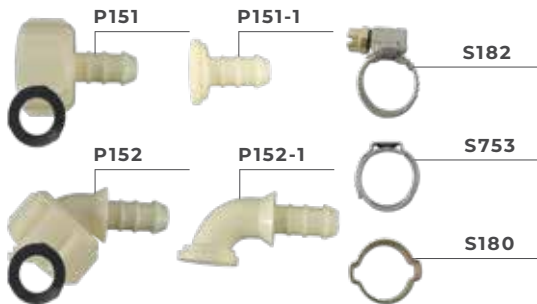

DESCRIPTION & COST:

P151	10mm Hose Conn Str w/nut & washer	0.46
P152	10mm Hose Conn Bent w/nut & washer	0.55
P151-1	10mm Hose Conn Str Fitting only	0.14
P152-1	10mm Hose Conn Bent Fitting only	0.23

10mm Hose Conns w/captive Washer

These are now very popular fittings. They have a much better nut and the washers are attached to the fitting. They are not suitable for use with filter washers.



DESCRIPTION & COST:

P660	10mm H/C Str w/nut & captive washer	0.59
P661	10mm H/C Bnt w/nut & captive washer	0.66

10mm Hose Fittings

Various fittings for use with 10mm inlet hose.

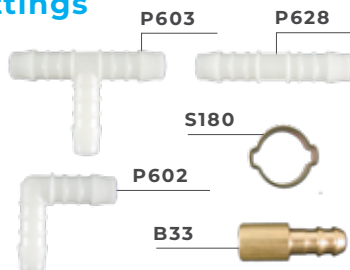

DESCRIPTION & COST:

B33	15mm Copper x 10mm Hose Adaptor	1.16
P602	10mm Hose Elbow	1.50
P603	10mm Hose Tee	1.50
P628	10mm Hose Coupling	1.04

12mm Hose Components

12mm Inlet Hose Connectors

Simply assemble using washing up liquid or silicone spray and secure with any of the clips shown. Available with or without nut and washer. Spare nuts and washers are also available as are screened filter washers (P157).

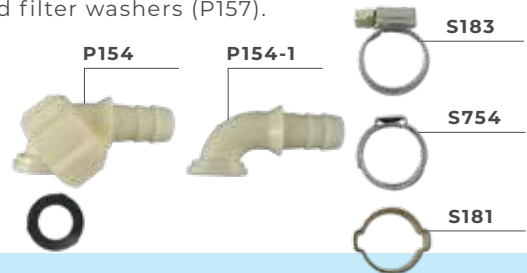

DESCRIPTION & COST:

P154	12mm Hose Conn Bent	0.67
P154-1	12mm Hose Conn Bent Fitting only	0.35

12mm Hose Conns w/captive Washer

These are now very popular fittings. They have a much better nut and the washers are attached to the fitting. Please note that the nuts do not interchange on these fittings. They are not suitable for use with filter washers.

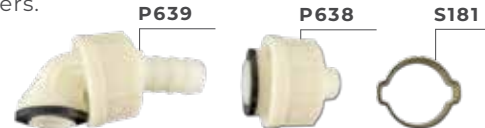

DESCRIPTION & COST:

P638	12mm H/C Str w/nut & captive washer	0.64
P639	12mm H/C Bnt w/nut & captive washer	0.76

12mm Hose Fittings

Various fittings for use with 12mm inlet hose & drain hose. Use 5/8 clip for drain hose & 3/4 clip for inlet hose.

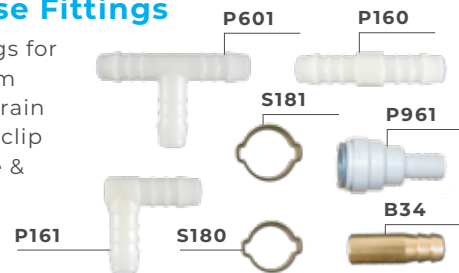

DESCRIPTION & COST:

B34	15mm Copper x 12mm Hose Adaptor	1.25
P160	12mm Hose Coupling	1.32
P161	12mm Hose Elbow	1.34
P601	12mm Hose Tee	1.89
P961	15mm Speedfit x 12mm Hose	2.19

SEE PAGE 43 FOR OUR GUIDE TO HOSES AND ASSOCIATED FITTINGS

GET IT TOGETHER

12mm Brass Hose Connectors

Brass fittings for use with 12mm inlet hose. Nut is the popular deep version.



DESCRIPTION & COST:

B860	12mm Brass H/C Bent Fitting Only	2.46
B861	12mm Brass H/C Str Fitting Only	0.77
B862	12mm Brass H/C Nut	0.77

19mm Hose Components

19mm Inlet Hose Connectors

Use these fittings with H149 19mm inlet hose. Fittings, nuts and washers all sold separately. Secure with 'O' clip (S752) 2 recommended.

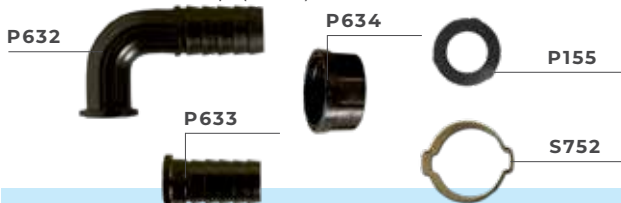

DESCRIPTION & COST:

P155	Hose Conn Washer	0.09
P632	19mm Hose Conn Bent Fitting only	0.73
P633	19mm Hose Conn Str Fitting only	0.33
P634	3/4" Black Nut for 19mm Fittings	0.22

19mm Brass Hose Connectors

Use these fittings with H149 19mm inlet hose. Fittings, nuts and washers all sold separately. Secure with 'O' clip (S752) 2 recommended.



DESCRIPTION & COST:

B811	19mm Brass H/C Str Fitting only	0.96
B812	19mm Brass H/C Bent Fitting only	4.10
B813	Brass Nut for 19mm Fittings	0.77
B876	3/4" Fibre Washer	0.09
P155	Hose Conn Washer	0.09

Nipples

Useful fittings for connecting to female components or joining hoses.



DESCRIPTION & COST:

P156	3/4" Short Nipple	0.23
P165	3/4" x 1/2" Short Nipple	0.28

Nuts

3/4" nuts. P158 can be used with most of the 3/4" fittings on this page. P903 is for use with any fitting except 19mm fittings and the bent 12mm fitting. P904 has a larger hole and is the recommended nut for the 12mm bent.



DESCRIPTION & COST:

P158	3/4" Deep Hose Conn Nut	0.23
P903	3/4" Nut Small Hole	0.22
P904	3/4" Nut Large Hole	0.22

Washers 3/4"



Rubber washer for use with any of our fittings. Fibre washers normally used where the hose connector and the component that it is being connected to are both metal.

Filter Washers

These can be used with any of the 3/4" fittings except ones with captive washers.

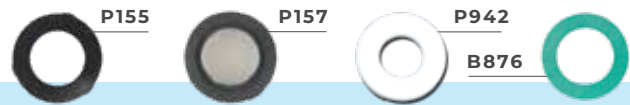

DESCRIPTION & COST:

B876	3/4" Fibre Washer	0.09
P155	3/4" Rubber Hose Conn Washer	0.09
P157	3/4" Screened Filter Washer	0.21
P942	3/4" Silicone Washer	0.12

Washers 1"



DESCRIPTION & COST:

P955	1" Fibre Washer	0.20
P956	1" Rubber Washer	0.21

1/2" Fittings

These fittings are for use with 12mm hose or drain hose. Some Autotrol valves have 1/2" male connections and these are the fittings to use.

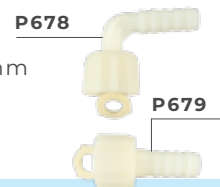

DESCRIPTION & COST:

P678	1/2" Hose Conn Bent w/nut & washer	2.01
P679	1/2" Hose Conn Str w/nut & washer	1.41

Blanking Discs

Use these discs to cap off by-pass valves when softeners are removed. You will need P158 nut and P155 washer.



DESCRIPTION & COST:

P629	3/4" Blanking Disc	0.34
------	--------------------	------

EXTRA HELP

Small Tube Cutter

Small cutter for use on all 3/8" and 1/4" tubes.



DESCRIPTION & COST:
T704 Small Tube Cutter 4.41

Hose and Tube Cutter

Large hose cutter is for use on all of our hoses and tubes.



DESCRIPTION & COST:
T703 Large Hose Cutter 25.09

JG Hose and Tube Cutter

Large hose cutter made by John Guest is for use on all of our hoses and tubes.



DESCRIPTION & COST:
T705 Large JG Hose Cutter 32.17

T.D.S. Meter

Pocket TDS meter. Features temperature function and hold facility as well as a leatherette case.



DESCRIPTION & COST:
T709 Pocket TDS Meter 22.58

Tank Air Gauge

Very accurate simple gauge for testing the air pressure in R.O. storage tanks.



DESCRIPTION & COST:
T707 R.O. Tank Air Gauge 9.17

Pressure Test Kit

Simple test kit utilising our liquid filled gauge. Fittings included allow for connection to outside taps, hoses, or washing machine/appliance valves.

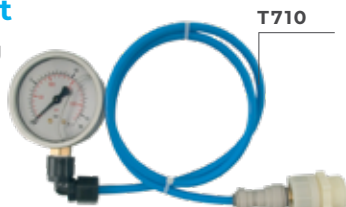

DESCRIPTION & COST:
T710 Pressure Test Kit 17.29

Faucet installation tool

Purpose made for installing faucets. The unusual style makes it easy and quick to use, even in the tightest spots.



Faucet Box Spanner

A useful box spanner for installing faucets. Comes with a bar, but is sometimes easier to use an adjustable wrench to turn it.

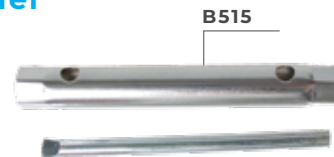

Monobloc Spanners

A useful set of box spanners for installing most types of monobloc mixer taps. 3 pieces (6 sizes) + bar.



DESCRIPTION & COST:
B514 Faucet Installation Wrench 5.30
B515 Faucet Installation Box Spanner 2.30
T716 Monobloc Spanner Set 5.72

Normal Closing Pincer

Use this tool for closing both 'O' clips and '1 ear' clips above. Can also be used to remove clips if required.



DESCRIPTION & COST:
T702 Normal Closing Pincer 17.66

Flexible Driver

Flexible driver specifically for worm drive hose clips. The socket end with flexible shaft means you will be able to apply ample pressure at any angle without the usual slipping.



DESCRIPTION & COST:
T711 Flexible Driver For Worm Drive Clips 5.58

SEE PAGE 8 FOR THE BESTSELLING
AQUAMATIC INTERTAPS

EVERYTHING YOU NEED

15mm Isolating Valves

Available for copper to hose e.g. appliances such as dishwashers and washing machines, and copper to copper. B38 is the same as B39 but has a check valve, so is perfect for filters, R.O.'s etc. Use with P676 (3/8) or P703 (1/4) adaptors, or standard hose fittings.



DESCRIPTION & COST:

B25	15mm Isolating Valve	5.97
B38	15mm x 3/4 Iso Valve w/check	7.53
B39	15mm x 3/4" Ball Valve	5.71
B507	Tee Type Ball Valve	4.30
P934	15mm JG Isolating Valve	6.39
B29	15mm Full Bore Iso Valve	4.80

Lever Ball Valve

Full bore long lever valve.

DESCRIPTION & COST:

B523	15mm Long Lever Ball Valve	6.75
B524	22mm Long Lever Ball Valve	10.83
B525	28mm Long Lever Ball Valve	18.65

SPEED-FIT PLUMBING FITTINGS

15mm Speed-fit

We stock a basic range of 15mm fittings including pipe inserts, a stem elbow and an isolating valve.

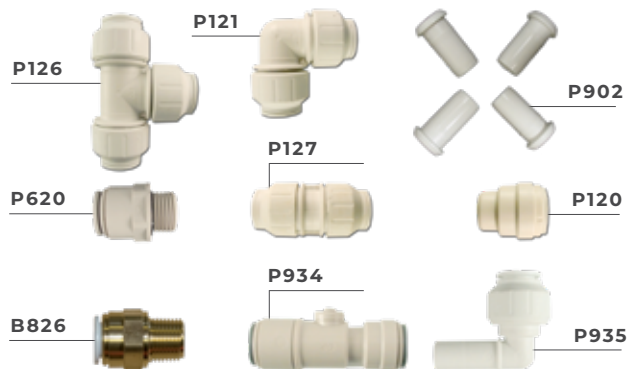

DESCRIPTION & COST:

B826	15mm x 1/2" JG Coupling	6.29
P120	15mm Speedfit Stop End	2.22
P121	15mm Speedfit Elbow	1.98
P126	15mm Speedfit Tee	2.85
P127	15mm Speedfit Coupling	1.65
P620	15mm x 1/2" Male Adaptor	1.83
P902	15mm J.G. Pipe Insert	0.33
P934	15mm Speedfit Isolating Valve	6.39
P935	15mm Speedfit Stem Elbow	3.86

22mm Speed-fit

We stock a range of 22mm Speedfit fittings.



DESCRIPTION & COST:

P131	22mm Pipe Insert	0.39
P132	22mm x 15mm reducing Stem	2.72
P133	22mm Speedfit Stop End	3.17
P134	22mm Speedfit Elbow	4.25
P135	22mm Speedfit Tee	4.23
P136	22mm Speedfit Coupling	2.61
P137	22mm x 15mm Speedfit Reducer	4.61



Unless stated otherwise, all items in a box with the WRAS logo shown here, have been tested and approved by WRAS

QUICK AND EASY

Speedfit Tube Fittings

Use for joining tube or connecting on to unthreaded tails e.g. our push-fit faucets or stem adaptors.

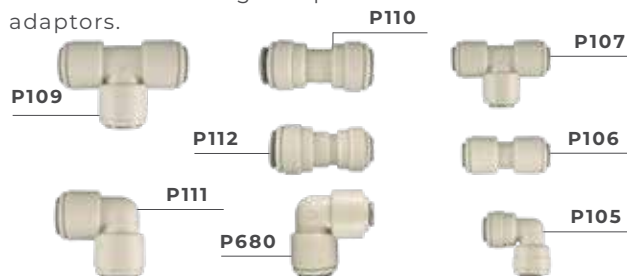

DESCRIPTION & COST:

P105	1/4" Elbow	1.03
P106	1/4" Coupling	0.87
P107	1/4" Tee	1.35
P109	3/8" Tee	1.63
P110	3/8" Coupling	1.19
P111	3/8" Elbow	1.53
P112	3/8" x 1/4" Reducer	1.18
P680	3/8" x 1/4" Reducing Elbow	1.64

Tap Adaptors

REMEMBER WHEN DESCRIBING TO SPECIFY TUBE SIZE FIRST FOLLOWED BY THREAD SIZE.

Tap adaptors are probably one of our most popular items. The 7/16" sizes are for use with faucets, while the 1/2" sizes will convert any 1/2" B.S.P. thread to take tube.

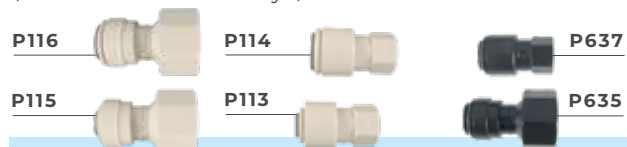

DESCRIPTION & COST:

P113	1/4" x 7/16" Tap Adaptor	1.22
P114	3/8" x 7/16" Tap Adaptor	1.24
P115	1/4" x 1/2" Tap Adaptor	1.24
P116	3/8" x 1/2" Tap Adaptor	1.24
P635	10mm x 1/2" Tap Adaptor	1.30
P637	10mm x 7/16" Tap Adaptor	1.24

Bulkhead Connections

Three sizes of bulkhead connector.



DESCRIPTION & COST:

P924	1/4" Bulkhead Connector	1.62
P925	1/2" Bulkhead Connector	4.08
P927	3/8" Bulkhead Connector	2.42



WRAS Approval
on all the items on this page

Rigid Elbows

REMEMBER WHEN DESCRIBING TO SPECIFY TUBE SIZE FIRST FOLLOWED BY THREAD SIZE.

Male thread x Speedfit elbow. Useful for filter housings and RO systems.

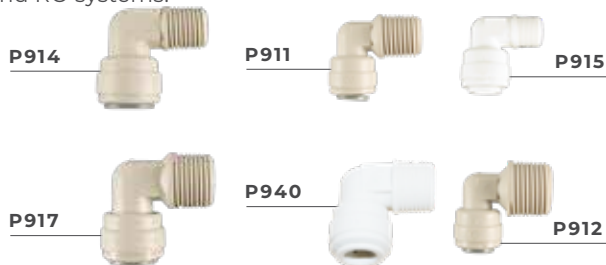

DESCRIPTION & COST:

P911	1/4" x 1/4" Rigid Elbow	0.89
P912	1/4" x 3/8" BSP Rigid Elbow	1.42
P914	3/8" x 1/4" BSP Rigid Elbow	1.49
P915	1/4" x 1/8" NPT White Rigid Elbow	0.75
P917	3/8" x 3/8" BSP Rigid Elbow	1.57
P940	3/8" x 3/8" BSP White Rigid Elbow	1.53

Male Adapters

REMEMBER WHEN DESCRIBING TO SPECIFY TUBE SIZE FIRST FOLLOWED BY THREAD SIZE.

Very popular fittings for use primarily on filter housings but can also be used for a variety of other applications e.g. in-line filters, R.O. membrane housings and shut-off valves.



DESCRIPTION & COST:

P117	1/4" x 3/8" Male Adaptor	0.64
P118	3/8" x 3/8" Male Adaptor	1.18
P119	1/4" x 1/4" Male Adaptor	0.69
P123	3/8" x 1/4" Male Adaptor	1.11
P128	1/4" x 1/8" Male Adaptor	0.61
P129	3/8" x 1/8" Male Adaptor	1.03
P620	15mm x 1/2" Male Adaptor	1.83
P636	10mm x 1/2" Male Adaptor	1.79
P670	6mm x 1/4" Male Adaptor	0.93
P931	3/8" x 1/2" Male Adaptor	1.54
P938	1/2" x 1/2" Male Adaptor	1.72

Speedfit Check Valves

Single check valves, speedfit connections both ends.



DESCRIPTION & COST:

P648	3/8" J.G. Check Valve	8.78
P910	1/4" J.G. Check Valve	6.44

QUICK AND EASY

Stem Fittings

A range of useful stem fittings. Elbows are helpful when sharp bends are required.



DESCRIPTION & COST:

P108	1/4" Stem Elbow	0.93
P124	3/8" Barb x 3/8" Stem	0.84
P125	3/8" Stem Elbow	1.69
P605	1/4" Tube x 3/8" Stem Reducer	0.84
P675	1/2" Barb x 3/8" Stem	0.92
P908	3/8" NPT x 3/8" Stem	0.62
P913	1/4" x 3/8" Stem Elbow	1.63
P923	1/8" x 1/4" Stem	0.59
P926	1/2" x 3/8" Reducing Stem	1.49
P928	15mm x 3/8" Reducing Stem	1.50
P930	15mm x 3/8" Stem Adaptor	1.80

Stop Ends & Plugs

Useful fittings for plugging existing components or capping tubes.

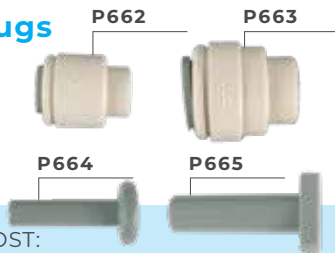

DESCRIPTION & COST:

P662	1/4" Stop End	0.40
P663	3/8" Stop End	0.47
P664	1/4" Plug	0.23
P665	3/8" Plug	0.36

Speedfit Isolating Valves

Simple isolating valves for filters and R.O. systems. P672 and P673 are straight in-line ball valves for 1/4" and 3/8" tube respectively. All make for quick and simple cartridge changes. P682 and P683 are for 15mm pipework and include a check valve.

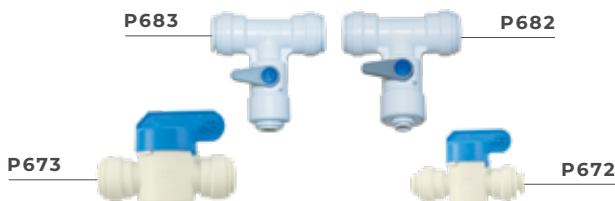

DESCRIPTION & COST:

P672	1/4" Ball Valve	3.22
P673	3/8" Ball Valve	3.42
P682	15mm x 1/4" Iso Valve w/check	12.52
P683	15mm x 3/8" Iso Valve w/check	12.95

1/2" Fittings

A limited range of 1/2" fittings and reducers are available from stock.



DESCRIPTION & COST:

P925	1/2" Bulkhead Connector	4.08
P926	1/2" x 3/8" Reducing Stem	1.49
P938	1/2" x 1/2" Male Adaptor	1.72
P939	1/2" Stem Elbow	1.79

5/16" Fittings

A limited range of 5/16" fittings and reducers are available from stock.



DESCRIPTION & COST:

P122	3/8" x 5/16" Reducing Elbow	1.67
P641	5/16" x 1/4" Reducing Elbow	1.19
P643	5/16" Elbow	1.01
P644	5/16" Coupling	0.91
P674	3/8" x 5/16" Reducer	1.37

Metric to Imperial Adaptors

From time to time you may need to get from 10mm to 3/8 or from 6mm to 1/4. Here are the adaptors you need.



DESCRIPTION & COST:

P966	10mm x 3/8 Adaptor	2.00
P967	6mm x 1/4 Adaptor	1.58

15mm x 3/8 JG Coupling

A coupling that goes straight from 15mm copper or plastic to 3/8 tube.

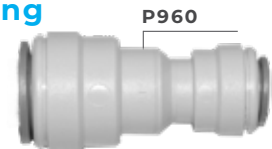

DESCRIPTION & COST:

P960	15mm x 3/8 JG Coupling	1.60
------	------------------------	------



All the items on this page are WRAS Approved

MAKING IT EASY

Brass Adaptors

A range of various useful brass adaptors. B863 & B894 are used to convert compression fittings to accept hose connectors.

See below for more on B895.

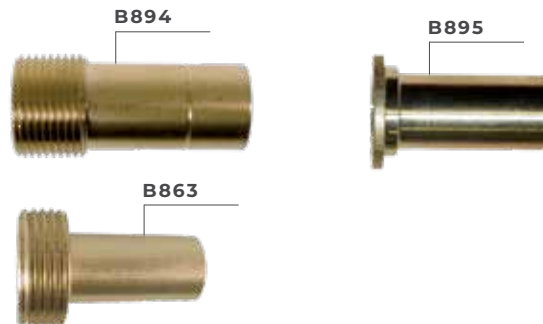

DESCRIPTION & COST:			
B863	3/4" BSP x 15mm Brass Adaptor		1.74
B894	3/4" BSP x 22mm Brass Adaptor		3.03
B895	3/4" Flat Face x 15mm Brass Adaptor		1.48

Connector Nipples

A range of plastic and brass nipples. Primarily used for joining filter housings but can be used for some other applications.



DESCRIPTION & COST:			
B56	3/4" Brass Hex Nipple		2.16
F261	3/8" Nipple		6.63
F274	1/2" Nipple		4.16
P701	3/4" x 3/4" Hex Nipple		0.75

3/4" BSP x Push-fit

These fittings can be used to convert any 3/4" B.S.P. thread to 3/8" or 1/4" tube e.g. appliance valves or outside tap thread. May also be used with nipple (P156) to connect 3/8" or 1/4" tube to a hose connector.



DESCRIPTION & COST:			
P676	3/4" BSPF x 3/8" Speedfit Adaptor		1.93
P703	3/4" BSPF x 1/4" Speedfit Adaptor		1.86
P906	3/4" BSPM x 3/8" Speedfit Adaptor		1.93

Reducers

2 new reducers are now in stock. 1" x 3/4" reducing nipple and 1" female x 3/4" male which is handy for softeners that have a 1" thread and you wish to use 3/4" hose connectors - you will need P955 fibre washer.



DESCRIPTION & COST:			
P941	1" M x 3/4" M Plastic Reducing Nipple		0.59
P957	1" F x 3/4" M Plastic Reducer		1.86

3/4" Flat face x 15mm Brass Adaptor

Another useful adaptor. Can be used on a 3/4 valve to provide a 15mm tail. A good example of this would be to retrofit a PRV to a softener. Simply remove the inlet hose and put this adaptor onto the valve with a nut (B862) connect the PRV and use B863 adaptor to get back to hose. Easy.



DESCRIPTION & COST:			
B895	3/4" Flat Face x 15mm Brass Adaptor		1.48

DID YOU KNOW
THAT YOU CAN DOWNLOAD
UNPRICED COPIES OF THIS
CATALOGUE FROM OUR
WEBSITE:
WWW.AQUAMATIC.CO.UK

new tap
catalogue

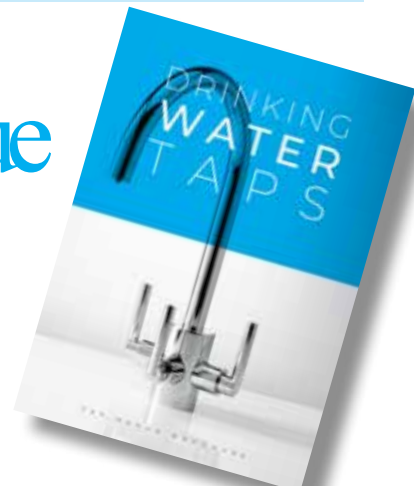

VALUE FOR MONEY

Drain Air Gaps

For a long time now we have had customers asking for an air gap for the drain connection on softeners and RO's which complies with the relevant regulation. There have been various items available (mainly products made for the American market) but they tend to be large and expensive. This product has been developed for the British market. This fitting has a lot of benefits, a few of which are listed here:-

- Reasonable cost
- Small size
- Can be used for softeners and/or RO's
- Optional saddle and trap
- Unique design allows fitment to any make of 1½" waste pipe
- Is available for 3/8" or 1/2" drain line, both have 1/4" str spigot for RO connection
- Easy to install - simply make a normal stand pipe with trap (or tee into an existing one) and solvent weld or silicone into place.
- Alternatively use the Gap Trap Kit on existing waste pipes.



P950 1/2"
P951 3/8"

DESCRIPTION & COST:		
P920	Drain Air Gap 1/2" Barb	2.52
P921	Drain Air Gap 3/8" Speedfit	2.52
P950	Gap Trap Kit 1/2"	15.04
P951	Gap Trap Kit 3/8"	15.04



Plumbing Out Kits

The ever popular plumbing out kit is now also available in white. Apart from the more attractive colour, the white version has crosshead screws for easier installation and is less costly too. Both are available with a 1/2" fitting or 1/2" and 3/8" fittings. Alternatively buy the adaptor separately and keep for the odd occasion when you need it. See page 25.



DESCRIPTION & COST:			
P162	Plumbing Out Kit 1/2"	8.18	
P907	Plumbing Out Kit 3/8" & 1/2"	10.11	
P162W	White Plumbing Out Kit 1/2"	7.02	
P907W	White Plumbing Out Kit 3/8" & 1/2"	8.86	

Overflow Elbow

Simple water softener 1/2" brine tank elbow.

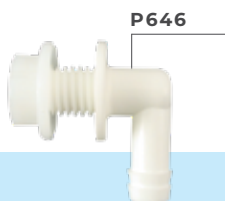

P646

DESCRIPTION & COST:		
P646	1/2" Overflow Elbow	0.99

Mini Stand Pipe Kit

This fast flow kit is widely used for the drain connection for water softeners. Its versatility and universal fitting means it will suit most applications. Supplied with cutting tool.



P166

DESCRIPTION & COST:		
P166	Mini Stand-pipe Kit	9.99



Just click on the heart in the app to start creating your own favourites list, and we can even prioritise your list so your most common parts appear first



THE PERFECT FIT

Compression Fittings

15mm Compression Fittings

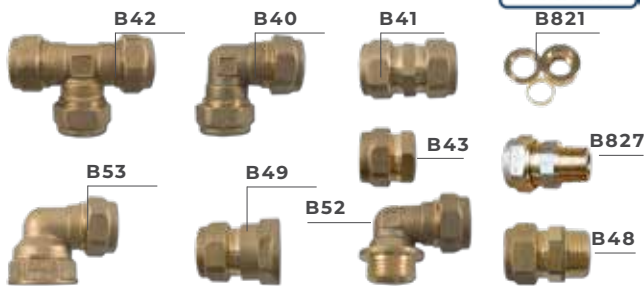

DESCRIPTION & COST:

B40	15mm Comp Elbow	1.32
B41	15mm Comp Coupling	1.28
B42	15mm Comp Tee	2.03
B43	15mm Comp Stop End	0.93
B48	1/2" MI Coupling	1.19
B49	1/2" FI Coupling	1.19
B52	1/2" MI Elbow	1.49
B53	1/2" FI Elbow	1.70
B821	22mm x 15mm 3pc Reducing Set	1.92
B827	15mm comp x 3/8 male	1.65

22mm Compression Fittings



DESCRIPTION & COST:

B44	22mm Comp Elbow	2.48
B45	22mm Comp Coupling	2.22
B46	22mm Comp Tee	3.59
B47	22mm Comp Stop End	1.56
B50	3/4" MI Coupling	1.95
B51	3/4" FI Coupling	2.09
B809	15mm x 3/4" MI Coupling	1.80
B810	22mm x 15mm Comp Reducer	2.30

Stopcock

Basic 15mm and 22mm compression stopcocks.

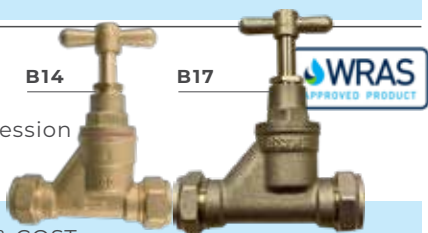

DESCRIPTION & COST:

B14	15mm Stopcock	6.09
B17	22mm Stopcock	13.26

PRICES EXCLUDE VAT

28mm Fittings



DESCRIPTION & COST:

B814	28mm x 1" MI Coupling	3.10
B815	28mm x 1" FI Coupling	3.15
B816	28mm Comp Coupling	4.50
B817	28mm Comp Elbow	4.40
B818	28mm Comp Tee	6.69
B819	28mm x 22mm 3pc Reducing Set	3.30
B820	28mm x 15mm 3pc Reducing Set	3.27
B823	28mm x 22mm Comp Reducer	3.62
B825	22mm x 1" MI Coupling	2.39
C90	28mm x 22mm E/F Reducer	1.16

End Feed Fittings

15mm End Feed Fittings

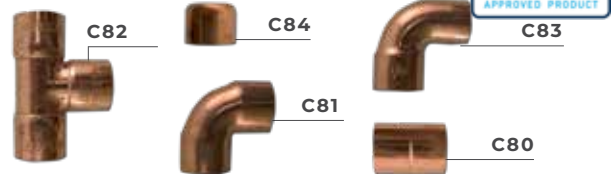

DESCRIPTION & COST:

C80	15mm E/F Coupling	0.20
C81	15mm E/F Elbow	0.30
C82	15mm E/F Tee	0.54
C83	15mm E/F Street Elbow	0.56
C84	15mm E/F Stop End	0.81

22mm End Feed Fittings

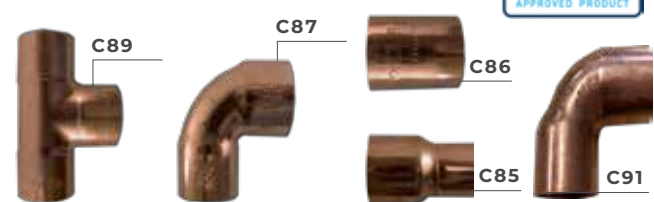

DESCRIPTION & COST:

C85	22mm x 15mm E/F Reducer	0.60
C86	22mm E/F Coupling	0.48
C87	22mm E/F Elbow	0.83
C89	22mm E/F Tee	1.52
C91	22mm E/F Street Elbow	1.25

THE PERFECT FIT

Single Check Valves



These are the ideal valves for the installation of water softeners. They are very small and compact and require no extra fittings. All this for a very reasonable price. Connections are CxC.



DESCRIPTION & COST:

B26	15mm Check Valve	5.63
B27	22mm Check Valve	8.73
B877	28mm Single Check Valve	11.97

Double Check Valves



Very reasonably priced double check valves for use primarily with outside taps but also suitable for any other application where a double check valve is required. Connections are C X C compression.



DESCRIPTION & COST:

B35	15mm Double Check Valve	4.95
B875	22mm Double Check Valve	10.07



WRAS Approval

Unless stated otherwise, all items in a box with the WRAS logo shown here, have been tested and approved by WRAS

Hose Union Bibcocks



B12. Standard garden tap available with or without double check valve. B13 double check valve version also has a drain point. The B22 is a new style of garden tap. The difference is that this one is a lever operated ball valve, thus offering better flow rates and ease of use, especially for older users or those with Arthritis etc. (not WRAS approved)

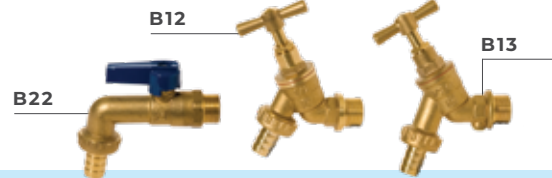

DESCRIPTION & COST:

B12	1/2" Hose Union Bibcockw	6.09
B13	1/2" Hose Union Bibcock W/ D/Check	8.16
B22	1/2" Hose Union Ball Bibcock	6.56

Backplates/Wallplates

B11. Standard backplate elbow for use with any of the taps here.

Pre-soldered Wallplate (not WRAS approved)

A pre-soldered wallplate for use with outside taps. It comes with 350mm or 600mm of 15mm copper already attached, so all you need to do is drill the hole for the tube and screws then make the relevant connections inside. A real time saver.

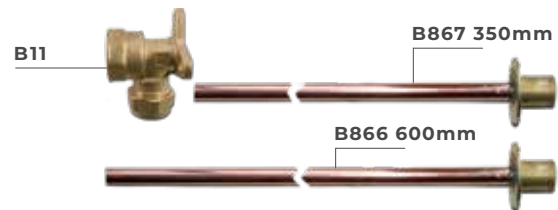

DESCRIPTION & COST:

B11	1/2" BSP Backplate Elbow	2.13
B866	Wallplate w/Copper Attached 600mm	11.43
B867	Wallplate w/Copper Attached 350mm	7.76



TRY OUR APP

A safe, secure and fast way of ordering the products you need to keep your business running.

UNDER PRESSURE

Pressure Reducing Valves

Top quality pressure reducing valves with excellent flow rates. Pre-set to either 5bar or 3bar. This component may be dismantled for cleaning or repair without being removed from the pipework. May also be adjusted on site if required - use the screw on top of valve. 1" version B94 requires 2 x B815 FI fittings if you wish to connect to copper.



DESCRIPTION & COST:

B7	15mm PRV 5bar/75psi	35.88
B8	15mm PRV 3bar/45psi	33.08
B9	22mm PRV 5bar/75psi	38.04
B93	Gauge for B94 PRV	4.64
B94	1" BSP male PRV w/gauge port	38.90
P953	3/8" Inline PRV 50 PSI	21.97

15mm Water Meter

After being discontinued by our previous supplier, we have finally managed to find a similar alternative.



DESCRIPTION & COST:

G602	15mm Water Meter	56.20
------	------------------	-------

Pressure Test Kit

Simple test kit utilising our liquid filled gauge. Fittings included allow for connection to outside taps, hoses, or washing machine/appliance valves.

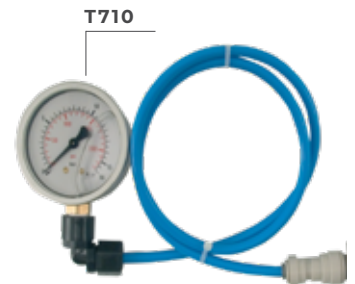

DESCRIPTION & COST:

T710	Pressure Test Kit	17.29
------	-------------------	-------

Fluidmaster Float Valves

The Fluidmaster (S209) offers good flow rates and more reliable operation. Use with any meter controlled softener to provide consistent flow rates.

NOW HAS BRASS TAIL to prevent crossed threads.

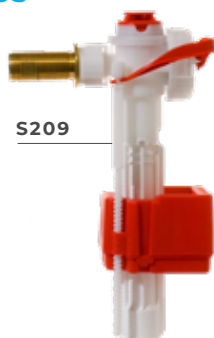

DESCRIPTION & COST:

S209	Fluidmaster Float Valve	15.18
------	-------------------------	-------

Quick Stop Valve Adjustable

Whilst the Fluidmaster valves are an excellent product, sometimes you just need a more flexible option to hand. Available in 1/2" and 3/4".



DESCRIPTION & COST:

S216	1/2" Quick Stop Valve Adjustable	13.16
S217	3/4" Quick Stop Valve Adjustable	18.70

LABEL IT, STOP IT



Customer bypass instruction label for sticking on the softener or on a wall/cupboard nearby. Can be used for any bypass but is especially suitable for use with our valve sets. Clear instructions on a polypropylene label. Supplied in packs of 10 or 50.

DESCRIPTION & COST:

L655-10 Bypass Instruction Sticker (Pk of 10 0.48ea)	4.80
L655-50 Bypass Instruction Sticker (Pk of 50 0.40ea)	20.00

Customer bypass instruction hanging card. Supplied with tie for hanging directly on the bypass set. Can be used for any bypass but is especially suitable for use with our valve sets. Clear instructions on a laminated card with reinforced eyelet. Supplied with ties in packs of 10 or 50.



DESCRIPTION & COST:

L656-10 Bypass Instruction Hanging Card (Pk of 10 0.60 ea)	6.00
L656-50 Bypass Instruction Hanging Card (Pk of 50 0.50ea)	25.00

Valve Labels

Made from plastic, these labels make identification of valves very easy for all customers. By-pass labels are supplied as a set, all others are supplied individually. All supplied with ties for attaching to pipe or valve.

DESCRIPTION & COST:

L650	Bypass Label Set	1.89
L651	Garden Tap Label	0.63
L652	Stopcock Label	0.63
L653	Drinking Water Label	0.63
L654	Boiler Bypass Label	0.63



L654

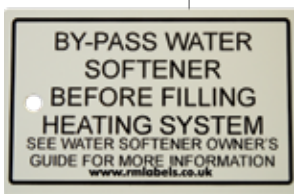

Boiler Bypass Label

An addition to our range of labels. This is for customers who have a boiler with an aluminium heat exchanger. It tells them to bypass the softener when filling the heating system so that the boiler manufacturers cannot claim that the soft water has damaged the boiler. Simply attach to the valve on the filling loop of the boiler.

DESCRIPTION & COST:

L654	Boiler Bypass Label	0.63
------	---------------------	------

Surestop Remote Mains Water Switch

DESCRIPTION & COST:

G603	15mm Surestop Valve w/remote	48.75
G604	22mm Surestop Valve w/remote	56.63



Water Block

SPECIFICATION & COST:

P918	3/4" Water Block	13.83
------	------------------	-------



P918

ATTENTION TO DETAIL

WD40

We all know how useful this is. Supplied in 450ml can with 2 spray options.



S221

DESCRIPTION & COST:

S221 WD40 450ml can 8.39

Amberclens

Since we showed this aerosol cleaner in our first catalogue it has become extremely popular. Primarily introduced for its suitability for cleaning softeners etc. We have had customers saying that they have used it on anything from televisions to windscreens. Thoroughly recommended.

S215



DESCRIPTION & COST:

S215 Amberclens 6.32

Cable Ties

These ties are very useful for tidying hoses, tubes etc to give your installations a neat professional look. Useful for a variety of other purposes as well.

S191

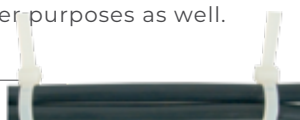

DESCRIPTION & COST:

S191 Cable Ties (pack 100) 3.75

Tub Of Big Wipes

Good for cleaning hands as well as paint, grease, adhesive, silicone, bitumen and much more. 80 wipes per tub.

S187



DESCRIPTION & COST:

S187 Tub Of 80 Big Wipes 8.48

Silicone Grease

Available in a tube or a spray can. Use for lubricating rubber seals, 'O' rings etc.



S218

S206

DESCRIPTION & COST:

S206 Silicone Spray 5.55
S218 Silicone Grease 9.75

Salt Scoop

Simple plastic salt scoop.

S220



DESCRIPTION & COST:

S220 Plastic Salt Scoop 1.88

PTFE Tape

P163



DESCRIPTION & COST:

P163 P.T.F.E. Tape 0.30

Fernox Leak Sealer

Silicone paste used as an external leak sealer and jointing compound, suitable for compression joints and screw fittings, WRAS approved too.



S194

DESCRIPTION & COST:

S194 Fernox Leak Sealer 50ml Tube 7.76

DID YOU KNOW
THAT YOU CAN DOWNLOAD
UNPRICED COPIES OF THIS
CATALOGUE FROM OUR
WEBSITE:

WWW.AQUAMATIC.CO.UK

1,2,3 TESTING

Hardness Water Test Strips

Pack of 50 strips for testing the hardness of water, with a handy colour comparison chart on the reverse.

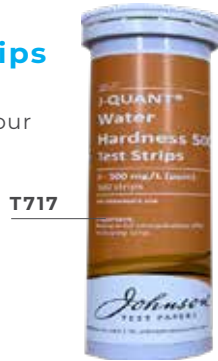

T717

DESCRIPTION & COST:

T717	Hardness Water Test Strips	5.40
------	----------------------------	------

Soft Water Test Kit

Use this Soft Water Soap Test Kit for a quick check to see if the water is soft. One drop of the solution will give you a quick answer.



T718

DESCRIPTION & COST:

T718	Soft Water Yes/No Soap Test	3.72
------	-----------------------------	------

T.D.S Meter

A good quality pocket TDS meter. It features a temperature function and hold facility as well as a leatherette case.



T709

DESCRIPTION & COST:

T709	Pocket TDS Meter	22.58
------	------------------	-------

Pressure Gauge

These gauges are filled with glycerine to provide accurate readings with no shock. Scale is 0-300 P.S.I. Stainless case with 1/4" bottom inlet connection. A must for all installers and service personnel.



DESCRIPTION & COST:

T706	Liquid Filled Pressure Gauge	13.65
T710	Pressure Test Kit	17.29

Total Hardness Test Kit

A slight change from the previous version. This one is much quicker and simpler to use to give results of water hardness in ppm. Very competitively priced too.



T715

DESCRIPTION & COST:

T715	Total Hardness Test Kit	15.48
------	-------------------------	-------

Hardness Stop/go Test Kit

Small, easy yes/no test kit. Simply fill to 20mm mark, put in 1 tablet. Colour indicates either hard or soft. Cheap enough to give away for customer reassurance.



T713

DESCRIPTION & COST:

T713	Hardness Stop/Go Test Kit	3.55
T714	Bottle of 250 Stop/Go Tablets	28.04

Tank Air Gauge

Very accurate simple gauge for testing the air pressure in R.O. storage tanks.



T707

DESCRIPTION & COST:

T707	R.O. Tank Air Gauge	9.17
------	---------------------	------



BENEFITS OF OUR APP

- Always available on PC, mobile or tablet
 - Custom made app, designed with you in mind
 - Featuring a handy 'downloads' section and 'favourites'
 - Pinpoint search facility
 - News updates
 - Easy checkout process
 - Multi-tier user access
- Contact us today to get you set up with an account

HIGHLY RECOMMENDED

Omnipure Valve in Head System

This system from Omnipure requires no tools or isolating valves to change the cartridge, the valve is automatically turned off as you unscrew the cartridge (by hand) and turned back on again when the cartridge is replaced. Available with G.A.C, Carbon block or G.A.C./Phosphate for scale reduction. Connections are 3/8" JG (F339).



DESCRIPTION & COST:

F328	8" G.A.C. Cartridge	14.53	F329	8" G.A.C./Phos Cartridge	18.37
F330	8" Carbon Block/Phos Cartridge	21.12	F339	Valved Head W/Brkt 3/8"JG	25.76
F408	12" G.A.C./Phos Cartridge	22.34	F409	12" KDF Cartridge	30.66
F446	10" G.A.C./Phos Cartridge	20.17	F495	8" Carbon Block Lead/Phos	25.06
F496	14" Carbon/Resin Cartridge	21.86			

Omnipure In-line Filters

These are very popular in R.O. applications as pre and post filters. This has 1/4" female connections



DESCRIPTION & COST:

F333	In-line Carbon 1/4" F T33	9.50
------	---------------------------	------



BENEFITS OF OUR APP

- Always available on PC, mobile or tablet
 - Custom made app, designed with you in mind
 - Featuring a handy 'downloads' section and 'favourites'
 - Pinpoint search facility
 - News updates
 - Easy checkout process
 - Multi-tier user access
- Contact us today to get you set up with an account

In-line w/speedfit fittings

F302 is carbon only whilst F321 is carbon/phosphate, both have 1/4" JG. F381 is carbon but with 3/8" JG connections. F415 is a remineralisation post filter for R.O systems. It has 3/8" JG connections.

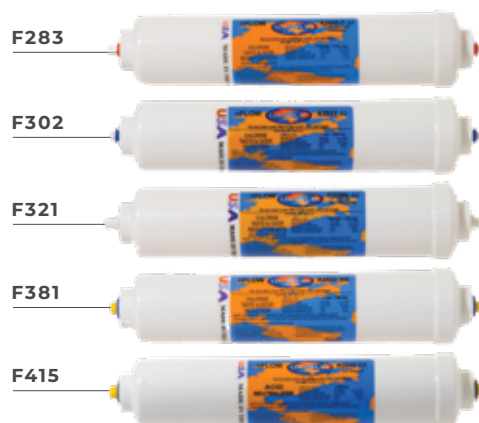

DESCRIPTION & COST:

F283	Inline Carbon Block 1/4" Speed-fit	17.27
F302	In-line Carbon 1/4" Speed-fit	10.75
F321	In-line Carbon/Phos 1/4" Speed-fit	15.38
F381	In-line Carbon 3/8" Speed-fit	12.07
F415	Remineralisation Cart 3/8" Speed-fit	11.77

HIGHLY RECOMMENDED

Cartridges for Omnipure RO

F386 is the 10" T28 prefilter whilst F387 is the 10" T33 post filter. The 2 cartridges can also be used with the omnipure head. (F339)



DESCRIPTION & COST:		
F386	10" G.A.C T28 For RO	16.11
F387	10" G.A.C. T33 For RO	16.11

Cartridge Cross Reference

K2333BB	F308
K2520JJ	F283
K2528BB	F333
K2528 or 33 or 36JJ	F302
K2533BB	F333
K2533KK	F381
B/Q5428 or 33	F328
B/Q5486	F329
B/Q5420P	F330
B/Q5528	F386
B/Q5533	F387
B/Q5572	F388
B/Q5415P	F495
B/Q5586	F446
B/Q5667	F409
B/Q5686	F408
B/Q5750	F496
Suffix BB = 1/4" F. JJ = 1/4" Speedfit. KK = 3/8" Speedfit	

DOULTON FILTERS & CANDLES

Doulton Candles

Doulton Ultracarb candle with short mount



DESCRIPTION & COST:		
F349	Ultracarb Candle 10"	20.46

Doulton Candles for Franke

F359. Replacement for Franke cartridges. Thread mounts are M15 and have a further 'O' ring on the tip of the thread. F359 has flat bottom which fits all Franke housings except the very latest ones with the candles with red caps. For these you need F369. This is the same apart from the spigot having no threads.



DESCRIPTION & COST:		
F359	Ultracarb for Franke w/flat bottom	20.46
F369	Franke Red Cap Equivalent Ultracarb	20.46

DID YOU KNOW

There is a 'Downloads' section on our app which contains the catalogue, tap catalogue and other handy guides and instructions

WWW.AQUAMATIC.CO.UK

KITS FOR EASE

PTL Valved Head Filter System

We now have in stock a very economical encapsulated filter system. These systems feature a concealed integral wall bracket, 1/4" pushfit fittings and a valved head for easy cartridge change. Cartridges are 5m carbon block, so ideal for taste/odour applications. Change 6 monthly. RO system also available see page 40.



DESCRIPTION & COST:					
F480	PTL 1/4" Valved Single Head	9.48	F481	PTL Carbon Block Cartridge 1M	12.60
F482	PTL Sediment Cartridge 5M	12.56	F483	PTL 1/4" Valved Double Head	14.48
F484	PTL Double Unit Sed/Carbon	39.63	F490	PTL Single Unit Carbon	22.07

Whole House Filter Kits

We can supply a kit for a whole house filter for customers wishing to filter all the water in the house. We have 4 options here using the Big Blue housings. 10" is suitable for smaller houses and any property with a storage tank. Any property with an unvented system will probably need a 20" housing. They can be supplied with a carbon block for customers wishing to remove chlorine, or a sediment cartridge for water that may be dirty. (It is not recommended to remove chlorine from water that will subsequently be stored in an open loft tank). These kits are supplied with a strong stainless bracket, spanner and fittings for connecting to 3/4" hose connectors for easy installation with hoses. They may be installed with their own bypass set (use the relevant size) or possibly share the bypass with a softener, in which case you will need another hose. Alternatively they can be hard plumbed in to the copper. Change times will depend on water quality and usage.



DESCRIPTION & COST:	
K210 Whole House Filter Kit 20" Carbon	217.02
K211 Whole House Filter Kit 20" Sediment	188.12



DESCRIPTION & COST:	
K212 Whole House Filter Kit 10" Carbon	165.45
K213 Whole House Filter Kit 10" Sediment	138.03

ADDED EXTRAS

Filter Isolating Valves

Simple isolating valves for filters and R.O. systems. P672 and P673 are straight in-line ball valves for 1/4" and 3/8" tube respectively. All make for quick and simple cartridge changes.

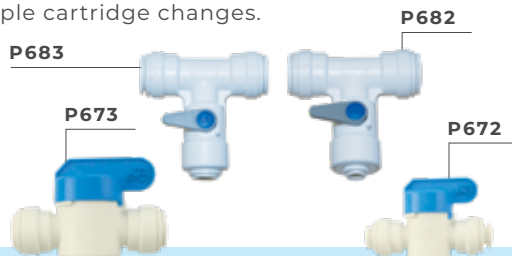

DESCRIPTION & COST:

P672	1/4" Ball Valve	3.22
P673	3/8" Ball Valve	3.42
P682	15mm x 1/4" Iso Valve w/check	12.52
P683	15mm x 3/8" Iso Valve w/check	12.85

Slimline Filter Brackets

Single or double brackets for slimline housings only. All supplied with screws. Double bracket is now galvanised



DESCRIPTION & COST:

F258	Single Bracket	4.91
F259	Double Bracket	5.24

Boxes

If you are offering a replacement cartridge service to your customers then you will need a box to post them in. These boxes are suitable for 10" cartridges, candles and membranes. Light construction for minimum postage charge. Designed to fit the current postal restrictions.



DESCRIPTION & COST:

F264	Single Cartridge Box	0.92
F442	Double Cartridge Box	1.30

Mounting Clips

F270. Fits all of our in-line filters. F423 clips 2 together.



DESCRIPTION & COST:

F270	Clip for In-line Cartridges	0.51
F423	Double 2" Clip for Inline Cartridges	0.54

Housing Wrenches

Our whole range here. Ensure you order the correct one. See housings for details.



DESCRIPTION & COST:

F260	Wrench for Slimlines	5.43
F277	Wrench for No10 & No20 Housing	5.57
F354	1/2 Round Filter Wrench	2.12
F377	Wrench for 20" Big Blue	9.67
F405	Wrench for 10" Big Blue	7.27

Connector Nipples

A range of plastic and brass nipples. Primarily used for joining filter housings but can be used for some other applications.



DESCRIPTION & COST:

B56	3/4" Brass Hex Nipple	2.16
F261	3/8" Nipple	6.63
F274	1/2" Nipple	4.26
P701	3/4" x 3/4" Hex Nipple	0.75

Replacement 'O' Rings

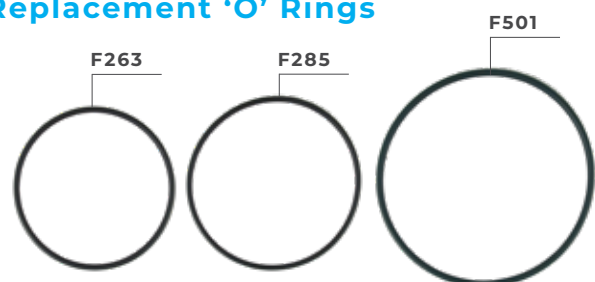

DESCRIPTION & COST:

F263	'O' Ring for Slimline Housing	1.78
F285	'O' Ring for no10 Housing	1.78
F501	'O' Ring for 10" & 20" Big Blue Housing	5.44

TRIED AND TESTED

Slimline Housings

All tried and tested Genuine Pentek (formerly Ametek) slimline housings. F450 & F465 are the later 3G type housings. They all take the standard 10" cartridges on the opposite page. Shown here are the relevant brackets, spanners and suggested fittings.



DESCRIPTION & COST:

B48	1/2" MI Coupling	1.19	B826	15mm x 1/2" JG Coupling	6.29
F250	3/8" Slimline Housing Blue	12.60	F251	3/8" Slimline Housing White	12.60
F258	Single Bracket	4.91	F259	Double Bracket	5.24
F260	Wrench for Slimline	5.43	F261	3/8" Nipple	6.63
F265	1/2" Slimline Housing	18.11	F450	3G S/L housing 3/8" Blue	24.73
F465	3G S/L Housing 1/2" Blue	24.73	P117	1/4" x 3/8" Male Adaptor	0.64
P118	3/8" x 3/8" Male Adaptor	1.18	P620	15mm x 1/2" Male Adaptor	1.83

3/4" No. 10 Housings

Heavy duty housings. For use where higher flow rates are required. Accepts all standard 10" cartridges. Connections are 3/4" B.S.P. female. Shown with relevant spanner and bracket.

DESCRIPTION & COST:

F466	3/4" no. 10 Housing	24.70
F267	'L' Bracket for no. 10 Housing	5.57
F277	Spanner for no. 10 Housing	5.57
F366	3/4" no. 10 Housing Clear	43.28



SEE PAGE 40/41 FOR R.O's

Why don't you try the new Aquamatic app, for fast efficient ordering

GREAT RANGE

Carbon Cartridges

We keep a good range of carbon cartridges including granular, granular/phosphate, carbon block, carbon block/heavy metals, extruded carbon. Many other styles are available. Please ask.



DESCRIPTION & COST:

F252	10" GAC Cartridge	10.58	F253	10" TSGAC Cartridge	19.41
F256	10" CBR Cartridge 0.5mic	21.17	F257	10" CBC Cartridge 0.5mic	18.63
F334	10" Matrikx Cartridge 5mic	5.73			

Sediment Cartridges

The most popular sediment cartridges are Osmonics Purtrex. Available in 1, 5, 10 or 20 micron. Also in stock are 10 and 20 micron wound 10" cartridges. All others are available. Please ask.

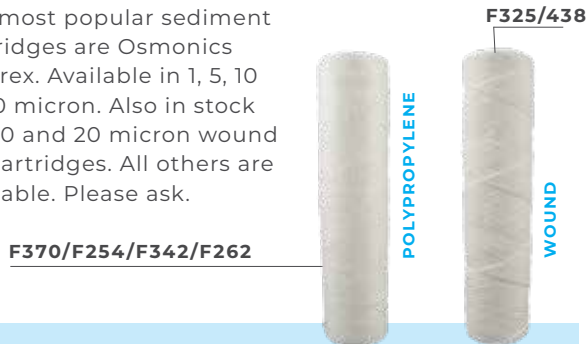

DESCRIPTION & COST:

F254	10" 5mic Sediment Cartridge	3.12
F262	10" 20mic Sediment Cartridge	3.12
F325	10" 10mic Wound Sediment Cartridge	3.36
F342	10" 10mic Sediment Cartridge	3.12
F370	10" 1 mic Sediment Cartridge	3.12
F438	10" 20mic Wound Sediment Cartridge	3.36

Special Cartridges

This range includes phosphate dosing, nitrate removal and mixed resin. F326 is simple insert which will convert any double open ended cartridge e.g. CBC or CBR into a scale reducing system.



DESCRIPTION & COST:

F307	PCC1 Phosphate Cartridge	61.82
F317	Nitrate Cartridge	28.59
F318	10" Mixed Resin Cartridge	27.21
F326	Phosphate Insert	10.51

Refillable Cartridges

Empty filter case for use with resin or carbon



DESCRIPTION & COST:

F323	10" Empty Filter Case	4.93
------	-----------------------	------

Matrikx Carbon Block Filters

We stock a limited range of Matrikx extruded carbon cartridges. Others are available to order.



DESCRIPTION & COST:

F334	10" Matrikx Cartridge 5mic	5.73
F335	20" Matrikx Cartridge 5mic	19.79

TRIED AND TESTED

20" Housings and Cartridges

20" housing with 3/4" ports. Cartridges shown are in stock with many more available to order. The relevant spanner and bracket is shown along with some suggested fittings. See also Matrikx for further 20" cartridges.

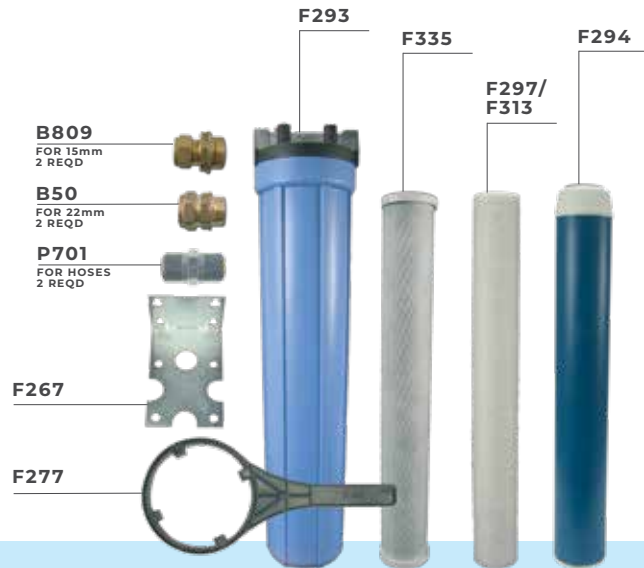

DESCRIPTION & COST:

B50	3/4" MI Coupling	1.95	B809	15mm x 3/4" MI Coupling	1.80
F267	'L' Bracket for no10 Housing	5.57	F277	Wrench for no10 Housing	5.57
F293	3/4" no20 Housing	61.82	F294	20" GAC Cartridge	21.17
F297	20" 5mic Sediment Cartridge	6.25	F313	20" 20mic Sediment Cartridge	6.25
F335	20" Matrikx Cartridge 5mic	19.79	P701	3/4" x 3/4" Hex Nipple	0.75

Big Blue Housings and Cartridges

Where higher flow rates and/or capacities are required (for example with whole house systems on unvented systems) these may be the filters for you, available in 10" or 20" with 1" threads. Many other cartridges are available to order. The relevant spanner, bracket and fittings are shown.

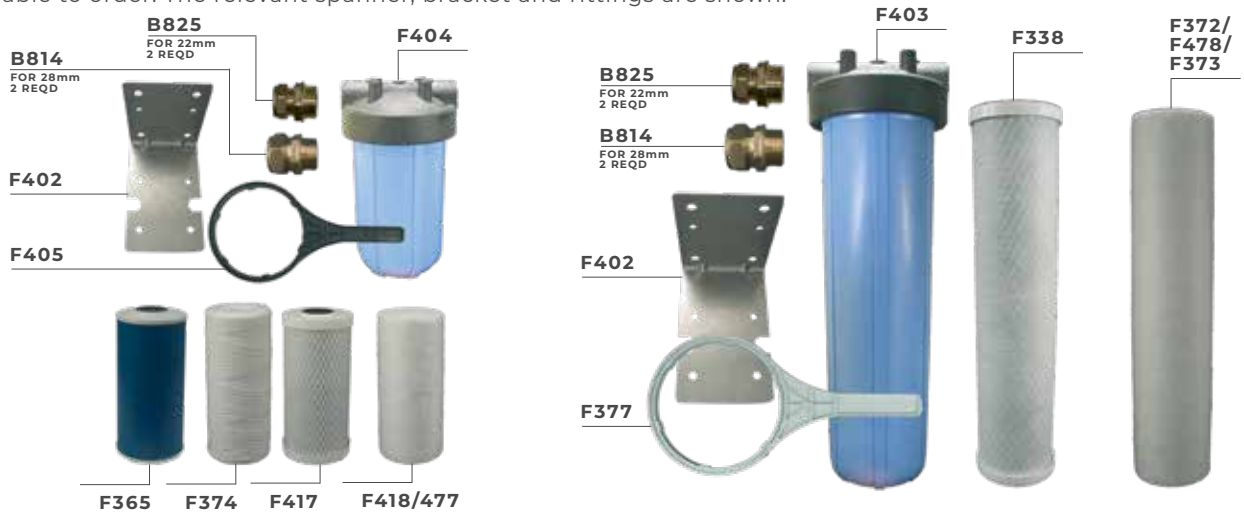

DESCRIPTION & COST:

B814	28mm x 1" MI Coupling	3.10	B825	22mm x 1" MI Coupling	2.39
F338	20" Big Blue Carbon Block 5mic	65.18	F365	10" Big Blue GAC Cartridge	31.62
F372	20" Big Blue Sediment Cart 20mic	36.28	F373	20" Big Blue Sediment Cart 5mic	36.28
F374	10" Big Blue Wound Sed Cart 10mic	18.67	F377	Wrench for 20" Big Blue	9.67
F402	Bracket for Big Blue Housing	37.76	F403	20" Big Blue Housing	101.63
F404	10" Big Blue Housing 1"	70.36	F405	Wrench for 10" Big Blue	7.27
F417	10" Big Blue CBC Cartridge	47.27	F418	10" Big Blue Sediment Cart 20mic	19.86
F477	10" Big Blue Sediment Cart 10mic	19.86	F478	20" Big Blue Sediment Cart 10mic	36.28

Products with part numbers
in **RED** may have to be ordered

GREAT VALUE

PTL R.O. System

Economy R.O. system available as a complete kit with tank, airgap tap, saddle valve, drain clamp and tubing.

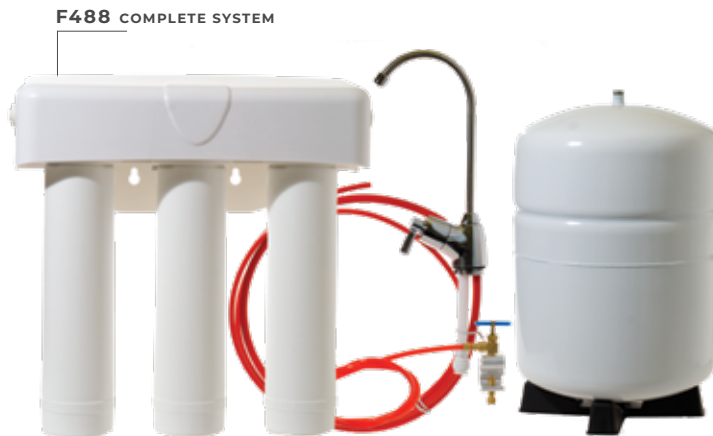

DESCRIPTION & COST:					
F488	PTL R.O Complete System	175.82	F489	PTL R.O. Membrane	48.69
F481	PTL Carbon Block Cartridge (2reqd)	12.60			

New Eco Membrane

One of the issues we hear about with RO's, is that they are not very efficient. Typically the ratio is 4:1, i.e. for every 1 litre of product water produced, 4 litres have run to drain. Pentair have released a new membrane that is 1:1 ratio which is obviously far more efficient for a similar performance. This is an encapsulated membrane and with speedfit connections for an easy, sanitary installation. We can supply this as a kit with relevant check valve and flow restrictor to retrofit to existing systems, or membrane only for future changes. Very easy to convert and only around 2" longer. *Our R.O's now come with these fitted as standard, please see next page..*



DESCRIPTION & COST:					
F343	Pentair Eco Membrane 50GPD	58.07	F344	Eco Membrane Initial Conversion Kit	66.66

R.O. Booster Pump

The key to good performance from any R.O. system is pressure. Unfortunately not all properties have sufficient pressure (usually a min requirement of 40 psi) to run an R.O. system effectively. The answer in this case is to fit a pressure booster pump. This pump is designed for use with R.O. systems up to a capacity of 50 gpd. It will take pressures as low as 10 psi and boost it to 100 psi. 1/4" Speedfit fittings are built into the head to ensure quick and easy installation. Supplied with a transformer as well as vibration damping mounting and tank shut off switch. Also included is an inline strainer F414 which should be fitted to protect the unit. Not suitable for Merlin/PRF systems.



DESCRIPTION & COST:		
RO851	RO Booster Pump	140.36

SEE PAGE 3/4 FOR THE NEW APL 3 WAY TAPS

HIGH PERFORMANCE

4 Stage R.O. System with New Eco Membrane

This is a well proven and high performing system that we have had built to our specification. It is pictured here and has the following features:-

- 4 stage filtration system
- 50 GPD Pentair Eco Membrane
- All JG fittings
- 3/8" tubing from tank to tap for faster flow rate
- Auto shut-off valve
- 4 Gallon storage tank
- Colour coded tubes and fittings for easy installation



One of the issues we hear about with RO's, is that they are not very efficient. Typically the ratio is 4:1, i.e. for every 1 litre of product water produced, 4 litres have run to drain. Pentair have released a new membrane that is 1:1 ratio which means that for every 1 litre of product water only 1 litre is wasted, this is obviously far more efficient for a similar performance. This is an encapsulated membrane and with speedfit connections for an easy, sanitary installation. In view of the constant pressure to reduce wastage, all of our systems are now fitted with this membrane. All other details remain the same.

Due to the increasing popularity of 3 way taps, we have more customers ordering the system only with taps or drain fittings. We therefore offer the system only here. Of course you can still add taps or drain fittings if required, just order separately and we can supply them as well. Suggested single tap would be the B20 intertap (see page 8) and the P950 gap trap kit for the drain (see page 26).

DESCRIPTION & COST:

F358-2	4 Stage R.O System only with Eco Membrane	197.14
---------------	--	---------------

Replacement Cartridges For R.O

The replacement filter and membrane for this system are listed here, replacements for other systems are shown on page 42



DESCRIPTION & COST:

F254	10" 5 Micron Sediment Cartridge	3.12	F334	10" Matrikx Carbon Block Cartridge	5.73
F381	In Line Carbon Filter 3/8" Speedfit	12.07	F343	Pentair Eco Membrane 50GPD	58.07

New Eco Membrane upgrade kit

Please see above for details of this membrane with our systems. This is an encapsulated membrane and with speedfit connections for an easy, sanitary installation. We can supply this as a kit with relevant check valve and flow restrictor to retrofit to existing systems, or membrane only for future changes. Very easy to convert and only around 2" longer. *New systems now have this membrane.*



DESCRIPTION & COST:

F343	Pentair Eco Membrane 50GPD	58.07	F344	Eco Membrane Initial Conversion Kit	66.66
-------------	-----------------------------------	--------------	-------------	--	--------------

PARTNER PARTS

Steel R.O. Tanks

F278. Standard steel storage tank familiar to most people, is a 4 gallon tank with nominal 2 gallon storage capacity. 1/4" male connection. Can be installed on its side if necessary on the stand supplied. Also available in a 2 gallon version with nominal 1 gallon capacity. F412.



DESCRIPTION & COST:

F278	4 Gallon Steel RO Tank	32.78
F412	2 Gallon Steel RO Tank	32.96

Tank Valves

Ball type angled tank valve for use on R.O. storage tanks. P625 1/4" female x 3/8" Speedfit tube connection. P626 1/4" version also available.



DESCRIPTION & COST:

P625	R.O. Tank Valve 3/8"	3.96
P626	R.O. Tank Valve 1/4"	3.76

Shut-off Valve

Nearly all R.O. systems incorporate a shut off valve to shut down the system when the tank is full. This one shuts off when the tank pressure is approx 2/3 line pressure and will replace most types. Connections are 1/4" pushfit.



DESCRIPTION & COST:

F296	R.O. Shut-Off Valve	19.21
------	---------------------	-------

Drain Flow Restrictor

Simple flow restrictor for use on R.O. drain outlets. Set at 300ml per min. Connections are 1/4" pushfit.



DESCRIPTION & COST:

F319	Drain Flow Restrictor 300ml	7.68
------	-----------------------------	------

Drain Saddle Clamp

This is the basic drain connection for use with R.O. systems. Use with the tube attached air gap faucet to make drain connections. For 3/8 tube.



DESCRIPTION & COST:

F311	Drain Saddle Clamp 3/8"	2.31
------	-------------------------	------

RO Membrane Housing

Standard 2 x 12 membrane housing. Also shown are the relevant fittings for use in it.



DESCRIPTION & COST:

F295	R.O. Membrane Housing	13.28
P915	1/4" x 1/8"NPT White Rigid Elbow	0.75
P923	1/8" NPT x 1/4" Stem	0.59

Membrane Housing Clips

F322 Plastic clips for use with membrane housings. F336 secures inline filter to membrane housing and F423 clips 2 inline filters together.



DESCRIPTION & COST:

F322	Membrane Housing Clip	0.51
F336	Double RO Clip	0.79
F423	Double Filter Clip	0.54

Check Valve Elbow

Screws straight in to membrane housing to incorporate a check valve in the product water outlet.



DESCRIPTION & COST:

F320	R.O. Check Valve Elbow	5.30
------	------------------------	------

R.O. Membranes

The two most popular R.O. membranes.



DESCRIPTION & COST:

F304	35gpd TFC Membrane	31.38
F341	50gpd TFC Membrane	32.69

T.D.S. Meter

Pocket TDS meter. Features temperature function and hold facility as well as a leatherette case.



DESCRIPTION & COST:

T709	Pocket TDS Meter	22.58
------	------------------	-------

Calcite Remineralisation Cartridge

Simply fit in the tube to the tap after the post filter. Best idea is to clip it to the post filter using 2 x F423.



DESCRIPTION & COST:

F415	10" Calcite Cartridge 3/8 s/fit	11.77
F423	Double Filter Clip	0.54

YOU NEED TO KNOW THIS

We have produced this guide to our most common hoses/tubes and their associated fittings to help you to select and use the most appropriate product for the required job. See the relevant pages in the catalogue for the full range.

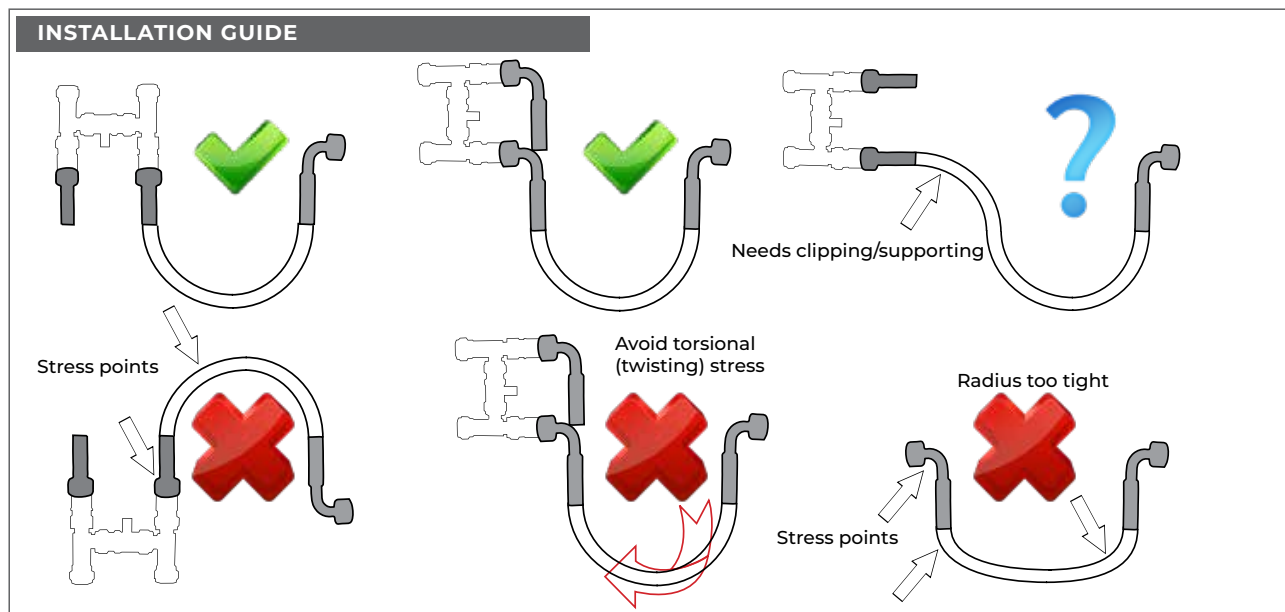

Product:- Assembled Hoses

Range of different hoses ready assembled for immediate use. Large range of different fittings available for many applications. Assemblies available in plastic or stainless.

Pros:-

Professional looking and ready to use. Much higher pressure rating due to machine swaged ends. Much better for DIY installations.

Cons:-

Slightly more expensive than self assembled. Not always correct length. Cannot be easily passed through walls, cabinets etc.

Tips:-

Keep a variety of lengths, formats on the van.



Product:- Stainless Hoses

Range of stainless overbraided EPDM rubber hoses available in 13, 19, and 25mm id. Suitable for use on cold and hot water. Also useful for industrial applications e.g. anti vibration for pumps etc.

Pros:-

Smart professional looking. Generally slightly more flexible than plastic hoses. Can be used on hot water.

WRAS approved

Cons:-

Only available as assembled hose as difficult to cut and fittings need to be machine swaged with ferrules.

Tips:-

Make sure that there is no torsional stress on the hose when fitted. If necessary use grips on the ferrule and a screwdriver in the elbow to turn it to the required angle. Keep away from corrosive materials.



Product:- Reinforced Inlet Hose

Range of reinforced inlet hose available in 6,10,12 and 19mm id. Can tolerate hot water but as pressure and bore size increase temperature limits decrease so we only recommend this for use on cold water. Commonly used on mains water supply for water softeners, vending machines, coolers etc.

Pros:-

Smart looking, available as assembled hoses or can be assembled on site. Wras approved product that will not grow bacteria.

Cons:-

Not recommended for use on hot water..

Tips:-

Keep away from heat sources - hot water/ heating pipes/boilers etc.

Product:- Drain Hose

White unreinforced PVC hose for use on drains and overflow. Heavy duty version has thicker wall for more resistance to kinking. Must not be used on mains water pressure.

Pros:-

Low cost attractive product.

Tips:-

Remember heavy duty version uses same fittings BUT needs bigger drill and clips. Clip frequently to prevent sags and kinks.

YOU NEED TO KNOW THIS

Product:- JG Tubing

LLDP tubing which is slightly more flexible than the standard LDP tube and is probably tougher and longer lasting.



Pros:-

Works consistently well with JG fittings (as you would expect).

Cons:-

Only available on 500' (150M) rolls.

Product:- Fittings with Captive Washer

Available for 10 & 12mm inlet hose. These are probably tougher than the standard Siroflex type and look good too. They also have the advantage that the washer does not keep dropping off, thus making the hose quicker and easier to connect. They cannot be used with filter washers.

Pros:-

Quicker easier to connect hose.

Cons:-

Cannot be used with filter/screen washers.



Tips:-

Ensure that washer retaining shoulder fits inside the valve or fitting that you are connecting to, otherwise you risk a leak. This is unusual though. Beware that 12mm elbow requires nut with large hole, all others in this range require nut with small hole.

Product:- Worm Drive Clips

Standard clip which can be used in many applications. Not recommended for 19mm inlet hose. Also available in all stainless.

Pros:-

Can be reused. No special tools required.

Cons:-

Can only be tightened a limited amount (sometimes not enough).

Tips:-

Use all stainless version if corrosion is a possibility.



Product:- Herbie Clips

A quick and easy to use clip for use primarily on drain hose. We stock 2 sizes for standard drain hose and heavy duty drain hose.

Pros:-

Quick, easy to use, and does not corrode. Can easily be undone and reused.

Tips:-

Make sure you keep both sizes if you use heavy duty drain hose.



Product:- Brass Fittings

We stock these for 12/13 mm, 19mm and 25mm hose. They can be used with brass or plastic nuts. P903/4 recommended if plastic.



Pros:-

Extremely tough and professional looking. Preferred fittings for use on hot water.

Cons:-

Pricier than equivalent plastic fittings.

Tips:-

If connecting to another metal/brass fitting use a fibre washer.

Product:- Siroflex Hose Connectors

Available in both 10mm and 12mm sizes bents and straights. Been around for years and familiar to most people. Items can be bought separately.



Tips:-

12mm straight has been discontinued (10mm version and elbows are fine).

Product:- 1 Ear Clips

Otherwise known as stepless clamps. These clips are available for 10 & 12mm inlet hose and are very popular as there is only one quick operation to secure. The tongue inside ensures a full 360° contact.

Pros:-

Quick, reliable and simple clamp.

Cons:-

Pricier than standard 'O' clips.

Tips:-

Ensure clip is at a perfect right angle to hose and that it is in the centre of the barb of the fitting. Close fully.



Product:- 'O' Clips

Standard type of hose clip. Primarily for use on inlet hose.

Pros:-

Simple established design.

Cons:-

Needs special tool to close. Cannot be reused.

Tips:-

Ensure clip is at right angle to hose and is in the centre of the barb. Recommend you use 2 clips with ears at 90° on 19mm hose. Ensure even closure of both sides.



EASIEST WAY TO FIND ANYTHING

Abode Taps	6	Matrikx Filters	38
Adaptors	23,25	Mini Stand Pipe Kit	26
Amberclens	31		
APL 3 Way Taps	3,4	Nail Clips	18
APL Intertap	8	Nipples	20,25
Backplates/Wallplates	28	'O' Clips	18
Blanking Discs	20	Omnipure Filters	33
Boiler Bypass Label	30	Overflow Elbow	26
Boxes	36		
Brass Adaptors	25	Pin Plugs	18
Bulkhead Connectors	23	Pipe Covers	18
By-pass Tees	11	Plumbing Out Kits	26
		Pressure Reducing Valves	29
Cable Ties	31	Pressure Test Kit	32
Cartridges	33	PTFE Tape	31
Compression Fittings	27	Quick stop adustable float valve	29
Double Check Valves	28	Refillable Cartridges	38
Doulton Filters	34	R.O. Membranes	42
Drain Components	26	R.O. Systems & Pumps	40-41
Drain Hose	17		
Drinking Water Tube	17	Salt Scoop	31
		Sediment Cartridges	38
End Feed Fittings	27	Silicone Grease	31
		Single Check Valves	28
Faucet & Taps	3-9	Speedfit Check Valves	23
Filter Kits (whole house)	35	Speedfit Fittings	22-24
Filter Washers	20	Stopcock	27
Fitting Kits	15-16	Surestop Remote Water Switch	29
Fluidmaster Float Valves	29		
Full Flow Ball Valves	10	Tank Valves	42
Full Flow By-pass Sets	12	Tap Adaptors	23
		T.D.S. Meter	42
Hardness Test Kit	32	Tools	21
Herbie Clips	18	Tube Attached Faucets	9
Hose and Tube Cutter	21		
Hose Assemblies	13-14	Valve Labels	30
Hose Union Bibcocks	28		
		Washers	20
Inlet Hose	17	Water Block	30
In-line Filters	33	Water Meter	29
		Worm Drive Clips	18
John Guest Fittings	23-24		
John Guest Tube	17		

THE SMALL PRINT

1. These conditions apply to all Aquamatic Products Ltd.'s (APL) sales and any variation to these conditions and any representations about the Goods shall have no effect unless expressly agreed in writing and signed by a director of APL. The Buyer acknowledges that it has not relied on any statement, promise or representation made or given by or on behalf of APL which is not set out in the Contract. Nothing in this condition shall exclude or limit APL's liability for fraudulent misrepresentation.

2. These conditions supersede any previous conditions on any other literature published by APL. Orders placed are deemed to be in accordance with these conditions which have precedence over any conditions the Buyer may wish to apply.

3. Payment. This is strictly cash with order, unless otherwise agreed in writing.

4. All price lists are subject to alteration without notice. Goods are invoiced at prices ruling at the date of despatch and orders are deemed to be placed on this basis.

5. Estimated delivery dates are those on which in good faith, we expect goods to be delivered to the Buyer. Every effort will be made to adhere to these dates. However we cannot accept responsibility for delays caused by circumstances beyond our control.

6. Acceptance of goods and liability. Any claims of damage in transit or short delivery must be notified to APL in writing within 3 days.

7. Claims of non delivery must be notified to APL within 7 days of receipt of invoice. Goods claimed to be not in accordance with the order must be retained as delivered for inspection and instruction. Failing this no liability will be accepted.

8. Product liability insurance must be carried by the Buyer against claims of damage arising from malfunction of any fittings or components supplied or any malfunction arising from their use.

9. Retention of title. Risk in the Goods sold shall pass to the Buyer at the time of delivery. Ownership of the Goods shall pass to the Buyer only when payment is made in full.

10. If the Buyer shall default in punctual payment of any sum due to us, we shall be entitled to recover any Goods seen to be our property. In addition, interest will be charged on overdue accounts.

11. (a) Alleged faulty or defective Goods shall be returned to APL's premises immediately, carriage paid and properly packed and clearly marked with the Buyer's full name and address together with a complete description of the respects in which it is alleged that the Goods are defective. Such Goods will be examined and should APL be satisfied that the Goods are defective, they will be repaired or new Goods will be supplied in exchange and the Goods so repaired or such new Goods will be delivered free of charge to the buyer at APL's expense. Provided that the foregoing warranty shall only be applicable if, upon being required by APL to do so, the Buyer proves to APL's satisfaction.

i) that the defect was due solely to APL's defective workmanship;

(ii) that no alteration or repairs have been made to the Goods except with specific written consent;

(iii) that the defect or defects were not caused by incorrect or negligent handling or storage, disregard of fitting instructions (where given), overloading, unsuitable application, faulty or negligent installation or any other default by the Buyer, his servants or agents.

(iv) That the defect was not caused by fair wear and tear, accident or any other reason beyond APL's reasonable control occurring after the date of the receipt by the Buyer.

(b) All costs and expenses, including freight charges, customs duties and insurance costs incurred in returning the Goods to APL in accordance with this condition shall be to the account of the Buyer. The benefits of this warranty shall not be assigned by the Buyer.

(c) The warranty contained in sub paragraph (a) above does not extend to any Goods or components not manufactured by APL although supplied by APL nor does it extend to any second-hand or reconditioned Goods or components. Goods or components not manufactured by APL carry only the warranty (if any) of their makers and the buyer is entitled to benefit thereof only so far as APL has the power to transfer it.

(d) The terms of this condition are in lieu of all conditions, warranties or other terms as to description, fitness for purpose, condition, merchantable quality or otherwise in respect of the Goods or repaired or replacement Goods whether expressed in the contract or implied by common law, custom or statute and notwithstanding that such purpose or condition may be, may become or may have been known to APL. Apart from APL's obligation to repair or replace Goods in accordance with the terms of this condition, no liability is accepted in respect of the Goods whether for consequential loss or loss or damages to third parties or otherwise.

(e) APL excludes any consequential losses occurring howsoever caused.

12. Descriptions and suggestions offered by APL throughout this catalogue or via any other media are for general guidance only. The installer is responsible for ensuring that any fittings used are suitable for purpose and fitted in accordance with professional standards

TAP WARRANTY

APL taps are sold on a trade basis. The warranty extends to the supply of replacement parts and does not cover on site service. This is the responsibility of the supplying dealer.

The warranty for Franke and Abode taps is with the manufacturer but is on a similar basis

The following 5 year warranty applies to APL 3 way taps.

Terms and Conditions

All working parts and valves are guaranteed for a period of 5 years from purchase. Surface finishes and O-rings are guaranteed for 1 year from the date of purchase provided that no scouring agents or chemicals have been used and that our care advice has been followed. This is provided that the tap has been used for normal domestic purposes and that the guidance in the installation instructions has been observed.

The following are not covered by the warranty
Damage including scuffs, scratches etc caused by accident, abuse or improper installation. Damage or malfunction caused by debris, solder or carbon fines in the water.

Replacement parts will be supplied under warranty at the discretion of APL

INSTALLATION
COMPONENTS FOR
THE WATER
TREATMENT INDUSTRY

TRADE
2022
CATALOGUE

AQUAMATIC PRODUCTS LTD
HYDESTILE STUD
HAMBLEDON ROAD
HYDESTILE
GODALMING
SURREY GU8 4DE
UNITED KINGDOM

Telephone: +44 (0)1483 861599
E-Mail: sales@aquamatic.co.uk
www.aquamatic.co.uk



This catalogue was published in April 2022.

In order to take advantage of continuing improvements we reserve the right to change products, specifications and prices without notice.

This catalogue and all material and images contained within it are the property of Aquamatic Products Ltd. and may not be copied or reproduced in any format without express permission of Aquamatic Products Ltd in writing.

e&oe

AQUAMATIC